



Miniload

Automated warehouses for boxes



Automated warehouses for boxes

Storage processes have become a strategic element in supply chain management and, therefore, in the creation of value in business.

In addition, the integration of automated systems in handling processes has a direct impact on the productivity of organisations, reducing costs and improving services in the supply chain.

This increase in productivity is even more apparent when automatic stacker cranes (miniload) are used in a warehouse for boxes. With these cranes, full use can be made of the height and width of space in the warehouse and the stored product brought closer to the operator, ensuring an efficient system for the preparation of orders.

Mecalux Group has more than 50 years' experience in the installation of storage systems and equipment for all sectors of the economy, using the most advanced technologies in industry.



Table of contents

Characteristics of automated warehouses for boxes	4
Basic components	6
Stacker crane	6
Racking	8
Picking and handling area	9
Management system	9
Load unit	10
Control and safety systems	10
Optional equipment	11
Optional elements	12
Load units	14
Extraction systems	16
Models of stacker cranes	18
Single or double depth	20
One or more aisles	22
One stacker crane per aisle	22
One stacker crane for several aisles	23
Several stacker cranes per aisle	24
Picking and replenishment positions	26
Role as buffer	38
Working temperatures	39
Combination with other warehouse systems	40
Support equipment for the preparation of orders	48
Automatic classification sorter	50
Warehouse management system	54
The advantages of automation	56

Automated warehouse system for boxes that combines racking, stacker cranes, conveyors, and warehouse management software as a single product.



Characteristics of automated warehouses for boxes

Optimal for storage and picking in accordance with the “product-to-man” principle.

These warehouses consist of one or more aisles with racking on both sides for storing boxes or trays, with a stacker crane moving up and down each aisle, moving and depositing boxes in their location. The picking and handling area, which consists of conveyors where stacker cranes deposit loads extracted from the racking, is located at one end or next

to the racking. The conveyors carry each box to the operator and once they have done their work, return the box on the stacker cranes to be placed in its correct position in the racking.

The whole system is directed by a management software program that records the location of all goods in the warehouse and keeps a real-time inventory in. As a result of its extraordinary ability to adapt, it can be integrated into any production or warehouse process.

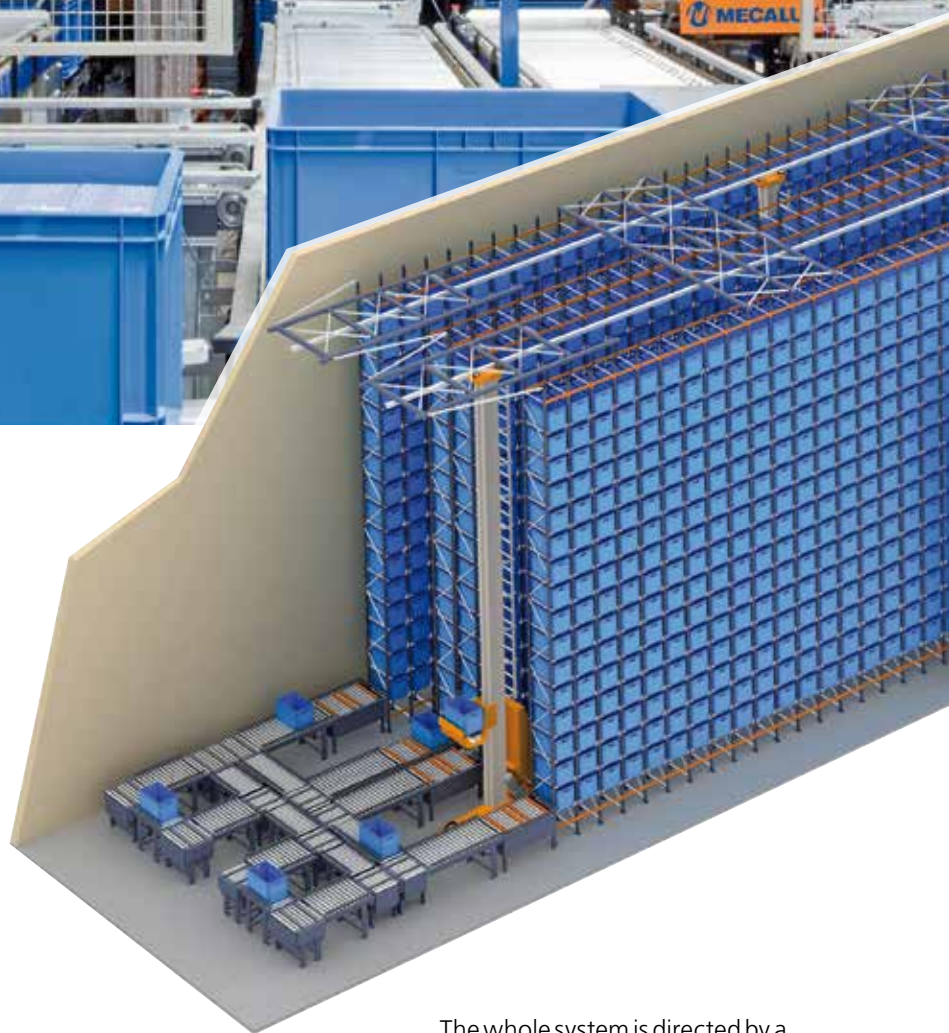



Advantages:

- It automates the entry and exit of products.
- It saves warehouse space.
- It eliminates the need for manually-operated turret trucks and averts accidents as a result of handling errors
- It eliminates errors resulting from manual handling in the warehouse.
- It monitors and updates inventory management.
- It can operate 365 days a year.
- It significantly increases capacity for customer service.
- It has a short return on investment period (ROI).

Basic components of automated warehouses for boxes

Automated warehouses for boxes consist mainly of the following elements:

- Stacker crane
- Racking
- Picking and handling area
- Management system
- Load unit
- Control and safety systems
- Optional equipment

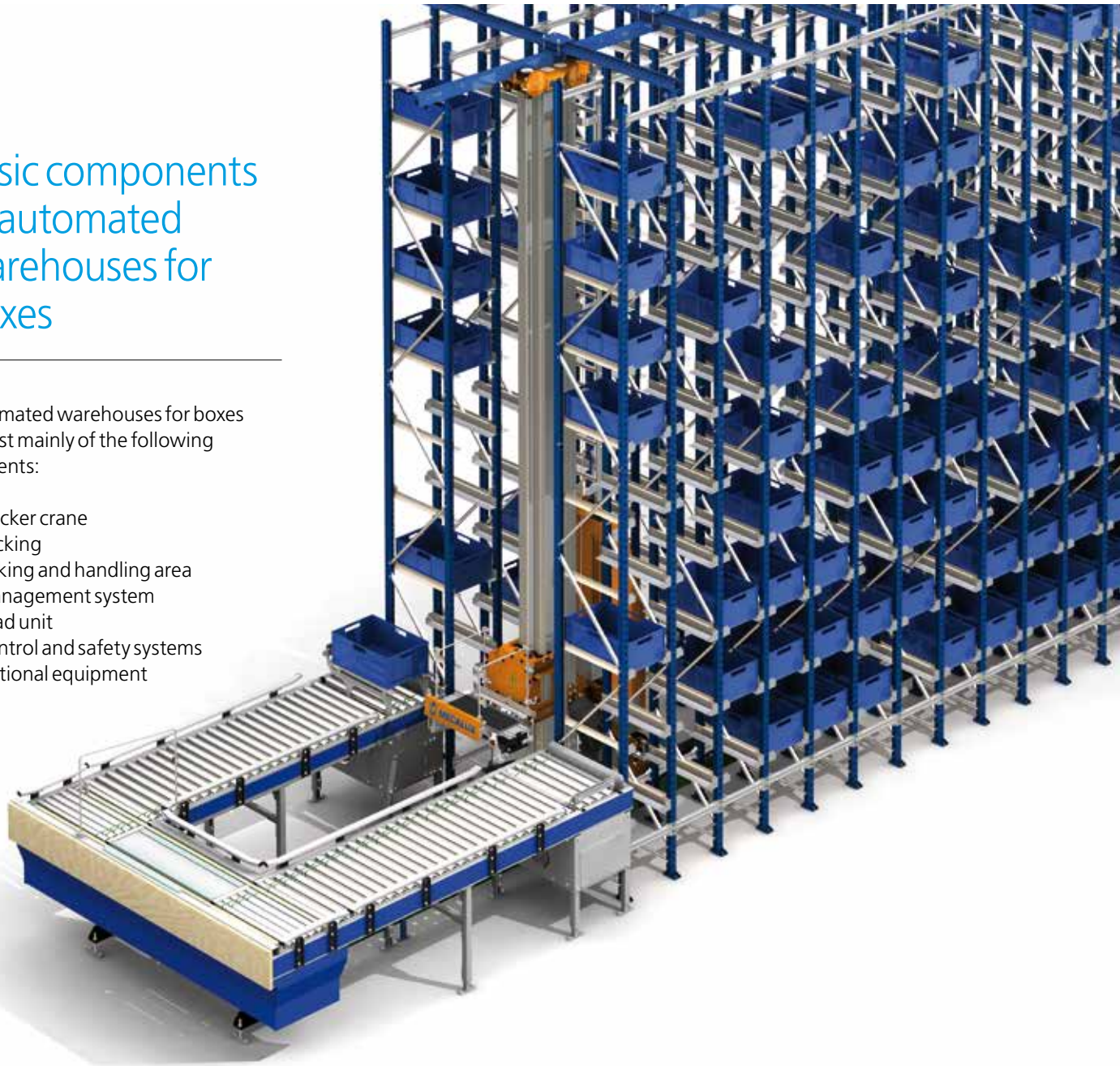

Stacker crane

A robot that locates and removes boxes on racking, and carries and deposits them on the conveyor in the header of the warehouse.

The crane can perform two movements: lateral, over the rail along the aisle and vertical, to place boxes on the different levels of racking as required. Lateral movements to extract and deposit boxes are performed using the extraction system located in the lifting cradle.



Components of the stacker crane

This robot, which can handle and store goods, consists of various elements that comprise an integrated unit. It moves around on rails embedded into the floor, with its upper section guided by a profile attached to the racking.

The correct position of the stacker crane is controlled using laser telemeters. Communication is via cable-free devices using infrared signals (communication photocells). For its power supply, it uses open fixed lines and glide plates.

1. Top guide base
2. Column
3. Bottom guide base
4. Remote electric box
5. Cradle and extraction system
6. Drive engine
7. Elevator motor
8. Laser telemeter
9. Cable-free communications equipment
10. Line for power supply
11. Lower track
12. Upper track
13. End-of-aisle stop

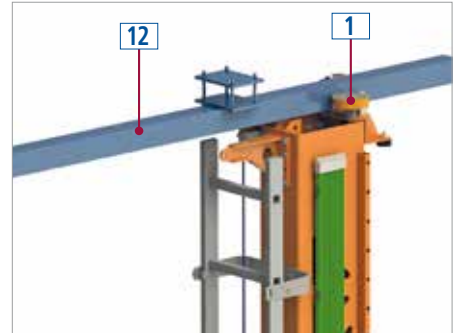
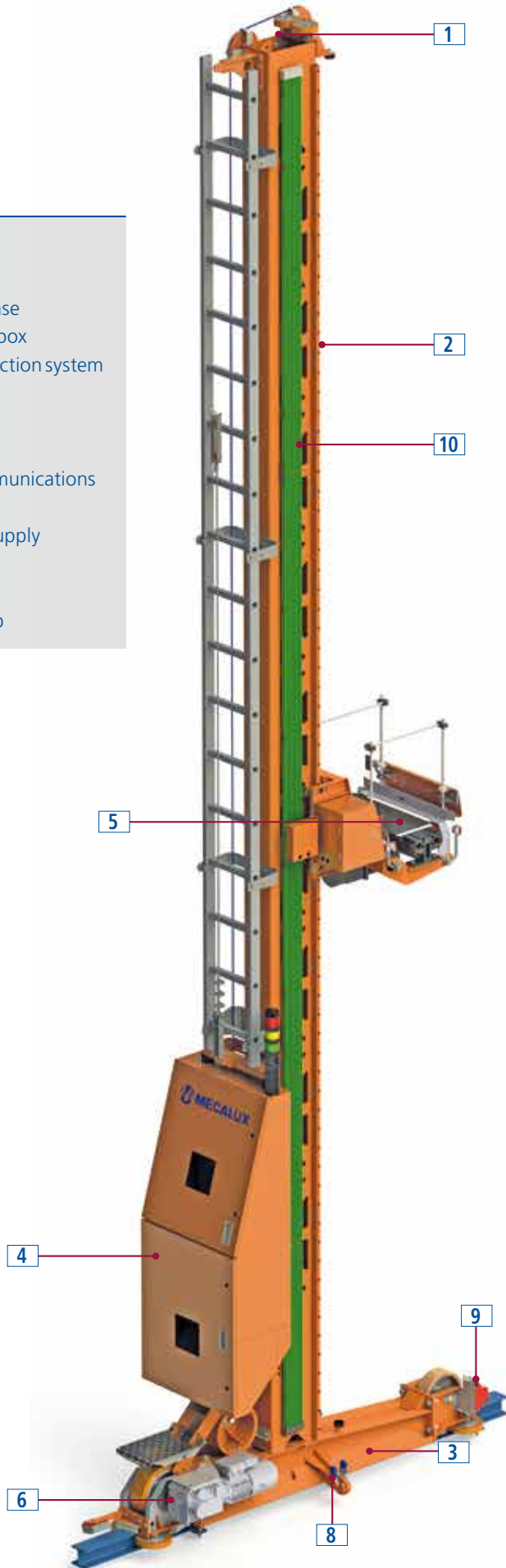

Top guide base (1) and upper track (12)



Cradle or mobile lifting frame (5)

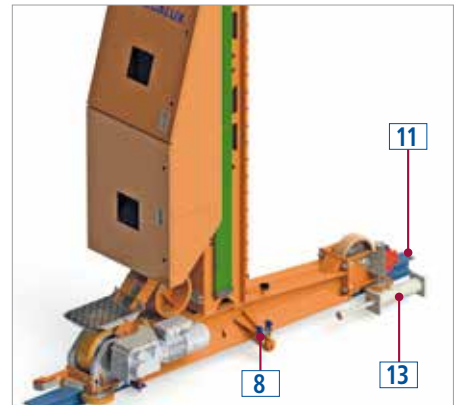

Lower track (11), hydraulic adjustment stop (13) and telemeter (8)

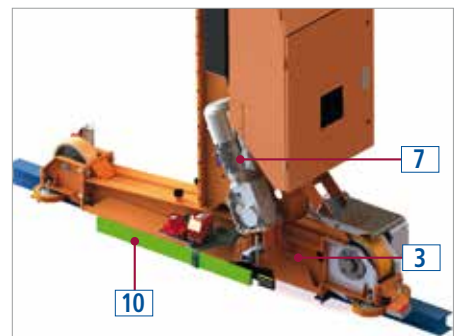

Bottom guide base (3), elevator motor (7) and power supply (10)



Racking

Designed for storing boxes in height, the racks are perfectly suited for the movement of the stacker crane. Their design allows for more efficient use of space and increased warehouse capacity.



Picking and handling area

This area is located next to or in front of the racking. This is where the mechanical movements need to bring the boxes closer to the operator or stacker crane occur, so that they can be collected and returned to their position in the warehouse.

This area consists of a series of conveyors that facilitate communication between work stations and stacker cranes, speeding up the entry and exit of goods from the warehouse.

There are two conveyor systems for boxes:

- Roller conveyors
- Belt or band conveyors

Management system

This system runs all the warehouse operations, making the most of the time and the use of warehouse space.

Its ease of use and integration make it a warehouse management tool that is in perfect symbiosis of the ERP of the client.

This software simplifies the management of all storage processes, and enables simple access to all information in real time.

It also keeps an ongoing, up-to-date inventory of all the goods in the warehouse.



Plastic box



Load unit

Automated facilities can also be made to store plastic, metal, or cardboard boxes. The most common plastic boxes are euroboxes that measure 400mm x 600mm or 600mm x 800mm, at normal height.

The ideal load unit in automated warehouses for boxes is determined based on the product to be stored.



Cardboard box

Control and safety systems

A powerful and experimented control software program, together with various mechanical and electronic devices, executes movements in a safe and accurate manner.

Steel mesh enclosures have been erected in open areas to prevent contact by operators with moving elements that could pose a risk. Access doors are connected to the control system, so that the machines stop when the doors are open.



Optional equipment

Other support equipment can also be included, such as:

- Barcode readers
- Report and label printer
- Scales
- Pick to light and put to light devices, etc.



Optional elements in an automated warehouse for boxes

Automated warehouses for boxes allow for different options according to the requirements of each facility. The options chosen will be in response to specific requirements to be met.

1. Load units
2. Extraction systems
3. Models of stacker cranes
4. Single or double depth
5. One or more aisles
6. One stacker crane per aisle
7. One stacker crane for several aisles
8. Several stacker cranes per aisle
9. Picking and replenishment positions
10. Role as buffer
11. Working temperatures
12. Combination with other warehouse systems
13. Support equipment for the preparation of orders
14. Automatic classification sorter

All of the above are suitable for:

- Heights of up to 20m
- Loads of up to 100kg per box
- Variable lengths



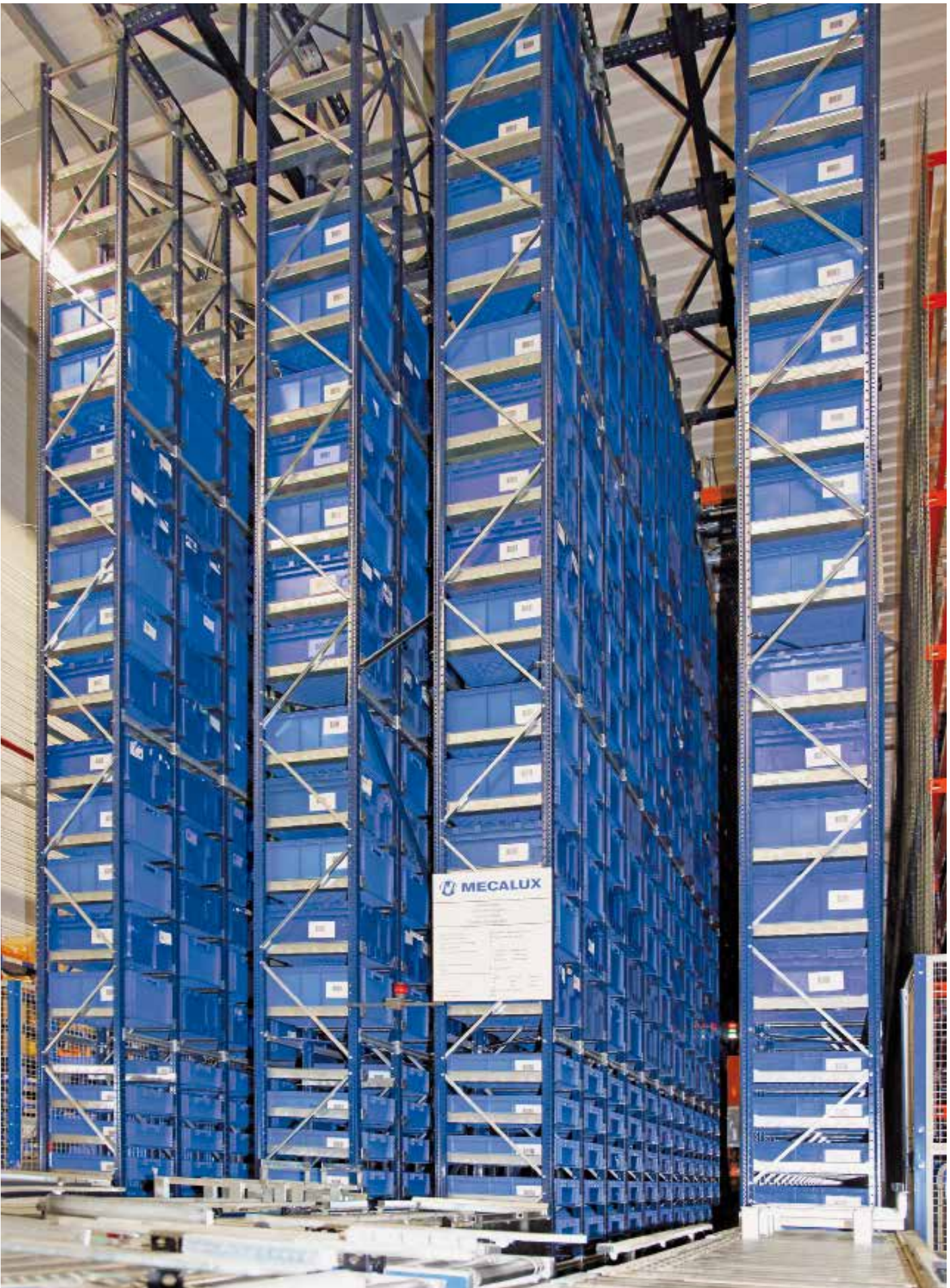



1

Load units

Automated warehouses for boxes are built for different load units. The most common of these load units are as follows:



Plastic box with dividers

Eurobox (400mm x 600mm)

- The most common model, due to its measurements and construction.
- Different heights that are suitable for the goods and the volume stored are available.
- The bases of the boxes can be smooth or reinforced, depending on their weight and use.
- Optional lid to protect the product.
- Option to incorporate subdivisions to store various SKUs without mixing them together.

Eurobox (600mm x 800mm)

- Used to store medium-sized products.
- Load capacity of up to 100kg.
- Various heights available.



Cardboard boxes

Medium-sized cardboard boxes can be stored directly without additional support (plastic boxes or trays) if they do not need to enter the warehouse again.

Even if the most used cardboard boxes have similar measures to plastic boxes, their variability, rigidity, and possible deformation mean that they require specific treatment.

Plastic or metal trays

Trays are used to store boxes and objects of varying dimensions, and are built specifically according to the product and the specific operations of each client. They can be made from plastic or metal.

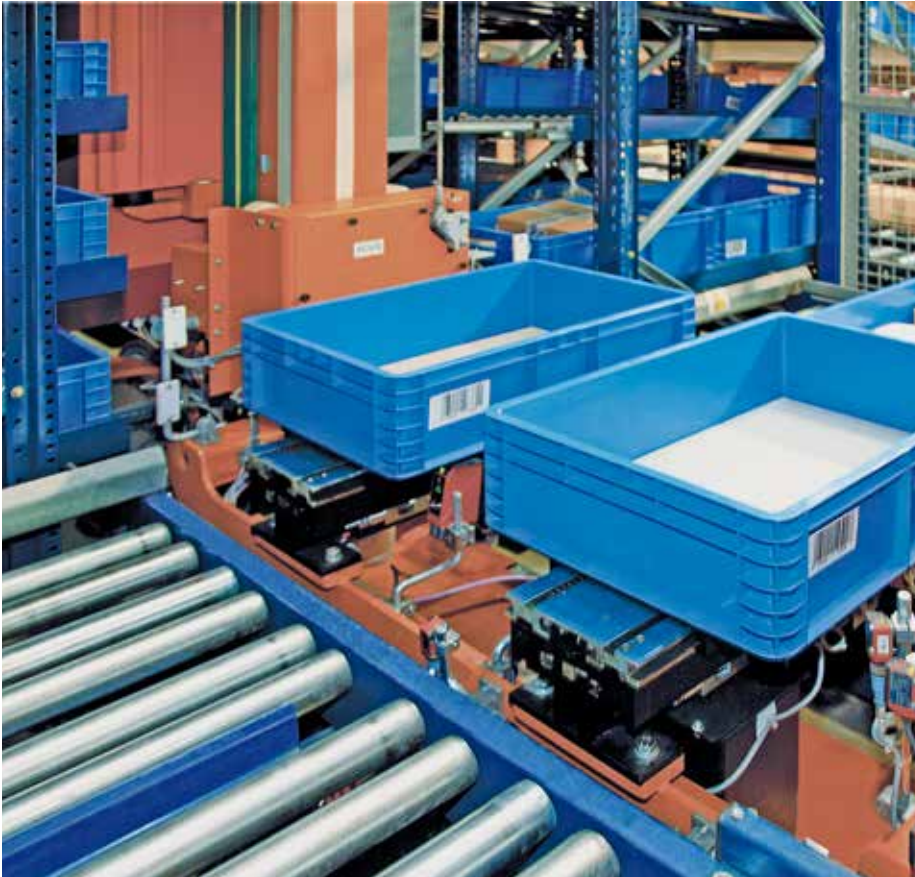

Extraction system with forks to extract two boxes at the same time



2

Extraction systems

Different extraction systems can be installed in the cradle of the miniload. The system chosen will depend on the product, the number of units to be handled, and the movements that will be required.

The cradle can host one or two extraction systems.

The most frequent of these are indicated below:



Extraction system with forks (EP)

This is the simplest and most commonly used system. The fork enters through the bottom and extracts the box.

There are two types of model for single and double depth. There is also a model that can extract two boxes at the same time.



Details of the extraction system that combines forks with belts (EC).



Extraction system that combines forks with belts (EC)

With this system, the forks are activated by belts that push and pull the load.

It is a fast-paced dynamic system that can move one or two boxes at once, as it is possible to work on both sides of the racking unit.

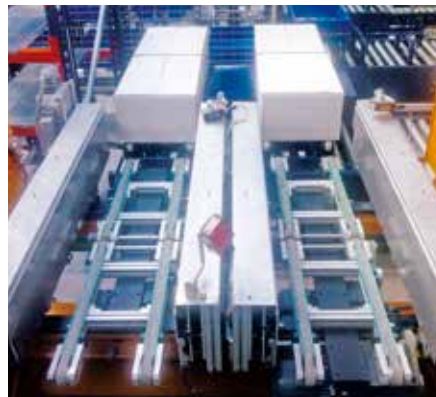

Cradle with two extractors that carries four boxes at once.

Extraction system with side claws (EG)

This is a system of vertical forks with semi-detachable shafts that hold up cardboard boxes (up to two at once). When the shafts are in a horizontal position, they trap the boxes to extract or push them along.

These forks also facilitate the movement of boxes to change the side or depth on the racking on which they have been placed.



3

Models of stacker cranes

Each warehouse requirement demands a different model of stacker crane.

There are three basic lines of stacker crane, each with different speeds and equipment depending on the services required.



The ML50

These vehicles are characterised by an slotted steel column that can handle up to 50kg at a height of 9m. Basically, this range is designed for high productivity.



The ML100

These vehicles have a maximum height of 12m, and can carry up to two 50kg boxes.

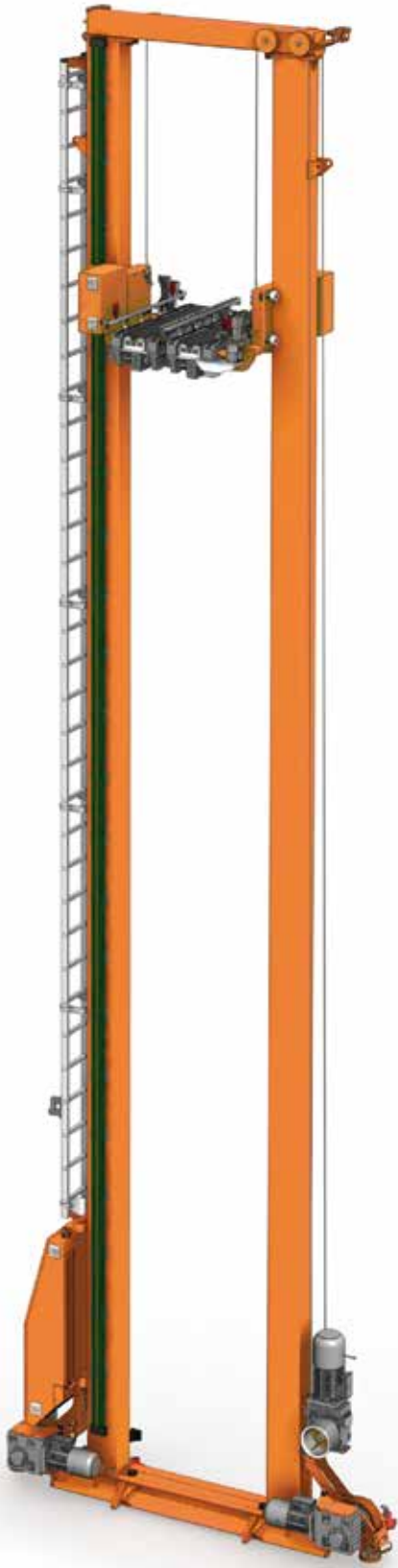

The MLB

These stacker cranes that can exceed 20m in height, and carry up to four 50kg boxes with two pieces of equipment for double extraction.





4

Single or double depth

This type of warehouse can be built to hold one box (single depth) or two boxes (double depth) on each side of the aisle.

Single depth

- One box per location on racking.
- **Maximum speed** of entries and extraction of boxes.
- Ideal for warehouses where priority is placed on the **speed of the system, rather than total warehouse capacity.**
- There is **direct access** to all boxes. Therefore, it is mainly used when the products stored are all of the same category and consumed in the same quantities, or when there is more than one box per SKU.



Double depth

- Two levels of depth in each location on the racking.
- Maximum box warehouse capacity.
- For companies that seek a perfect balance between warehouse capacity and speed of handling.

There is direct access to the boxes in front, while those behind them require the ones in front to be moved before they can be accessed. While at first this would appear to be a disadvantage, this is not the case in warehouses with a mix of A, B, and C products ("A" products being high-consumption products, "B" products medium-consumption, and "C" products low-consumption) since:

- The reserve box with product A is placed in the box behind the front row.
- Product C can be placed in the second position.

Warehouse with double depth

- Given that it is usually known what will be prepared beforehand, during idle-time products can be repositioned so that those that will leave first are placed in front. It also allows renovations of boxes to be carried out outside of business hours.
- Capacity per aisle is doubled.



5

One or more aisles

Automated warehouses for boxes, which are of variable height and length, can consist of one or more aisles, depending on the exact warehouse capacity, the dimensions of the warehouse, and the required number of movements.

6

One stacker crane per aisle

The most common arrangement is to install one stacker crane per aisle. The model and number of extractors will depend on the load unit and the needs of the client.



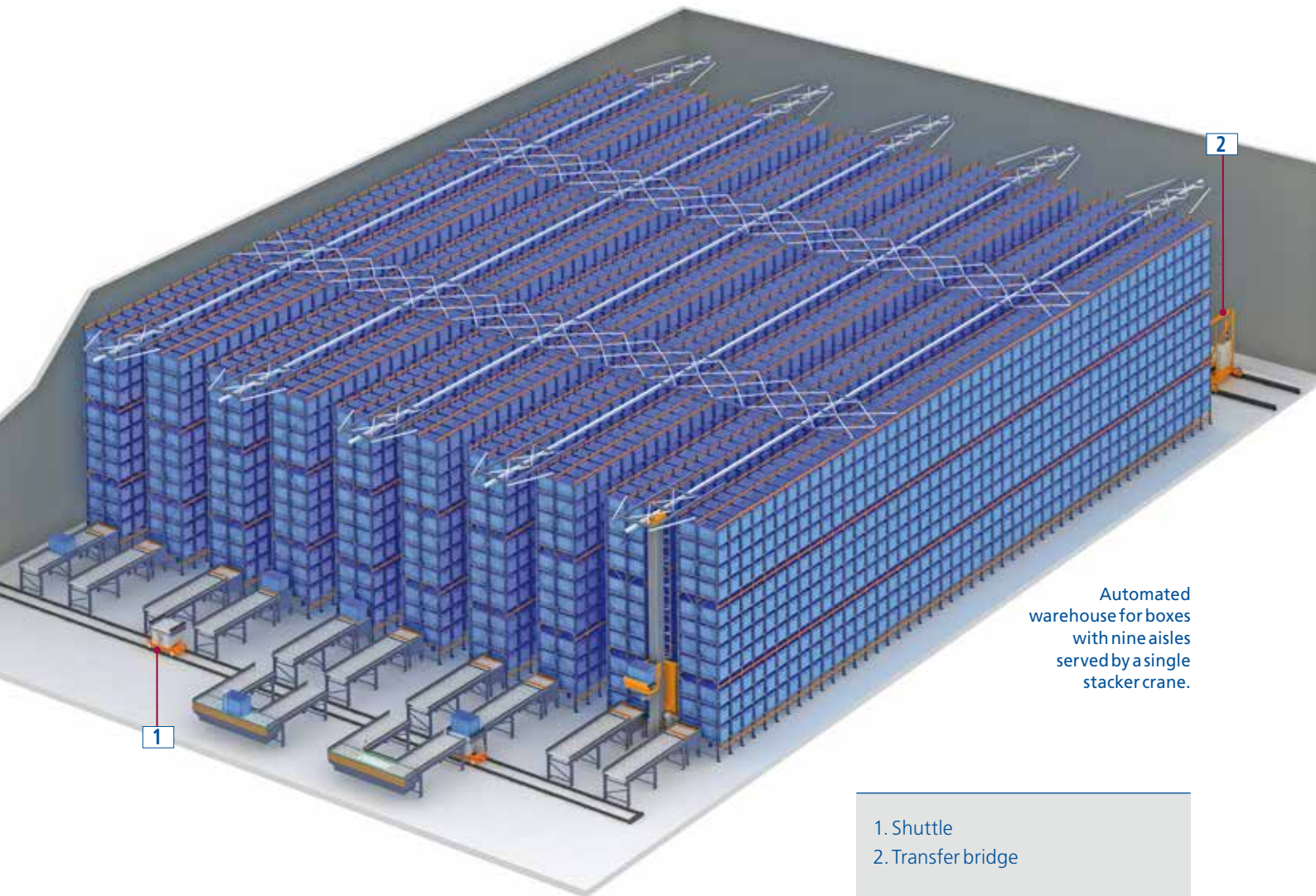

Automated warehouse for boxes with nine aisles served by a single stacker crane.

- 1. Shuttle
- 2. Transfer bridge

7

One stacker crane for several aisles

In warehouses with little movement, one stacker crane for several aisles is sufficient. To change aisles, there is a transfer bridge located at the rear of the warehouse.

To move boxes to the various picking positions, a shuttle in the front could be sufficient, rather than a circuit of conveyors.



Details of a shuttle (1).



Details of a transfer bridge (2).

8

Several stacker cranes per aisle

Two stacker cranes that move in the same lane in the same aisle can be installed, albeit with certain restrictions.

Another solution is to position two or more stacker cranes in height, as shown in these images.

For this, the racking incorporates auxiliary structures such as elevated aisles, with support and guide lanes along which stacker cranes move.

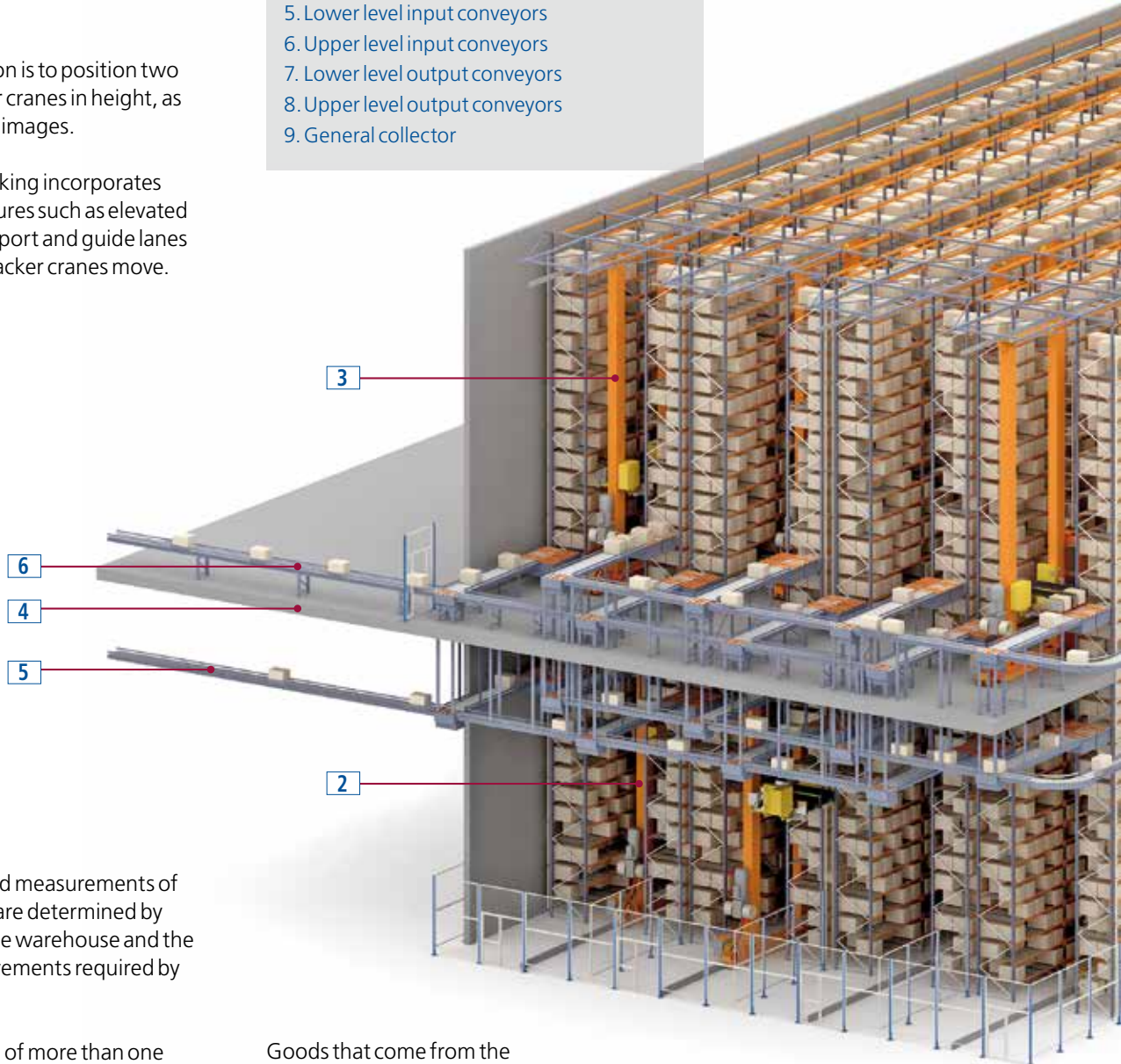

The number and measurements of stacker cranes are determined by the height of the warehouse and the number of movements required by the system.

The installation of more than one stacker crane in height multiplies the number of movements. This, when combined with the correct choice of model of machine, will result in an increase in the capacity of locations, as well as an increase in flows. Therefore, it is a very suitable solution for warehouses considered high-performance, or when the warehouse is used for sequencing purposes.

Goods that come from the production or reception areas are sent to the appropriate level using forklift trucks that send them to separate channels with sloping sections.

In the image, there are separate entry and exit channels that prevent products from being mixed together and can result in very high flows.

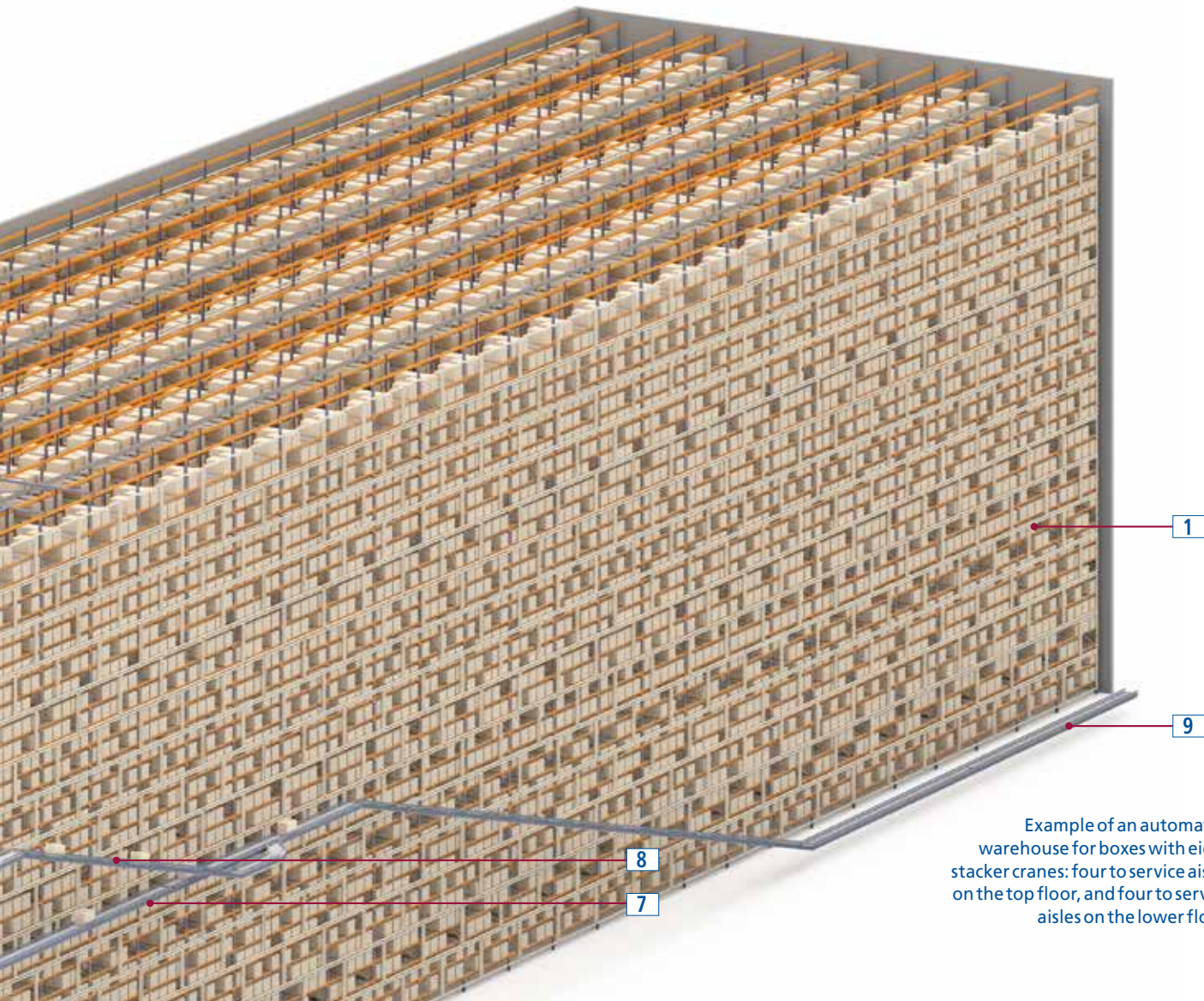

Example of an automated warehouse for boxes with eight stacker cranes: four to service aisles on the top floor, and four to service aisles on the lower floor.

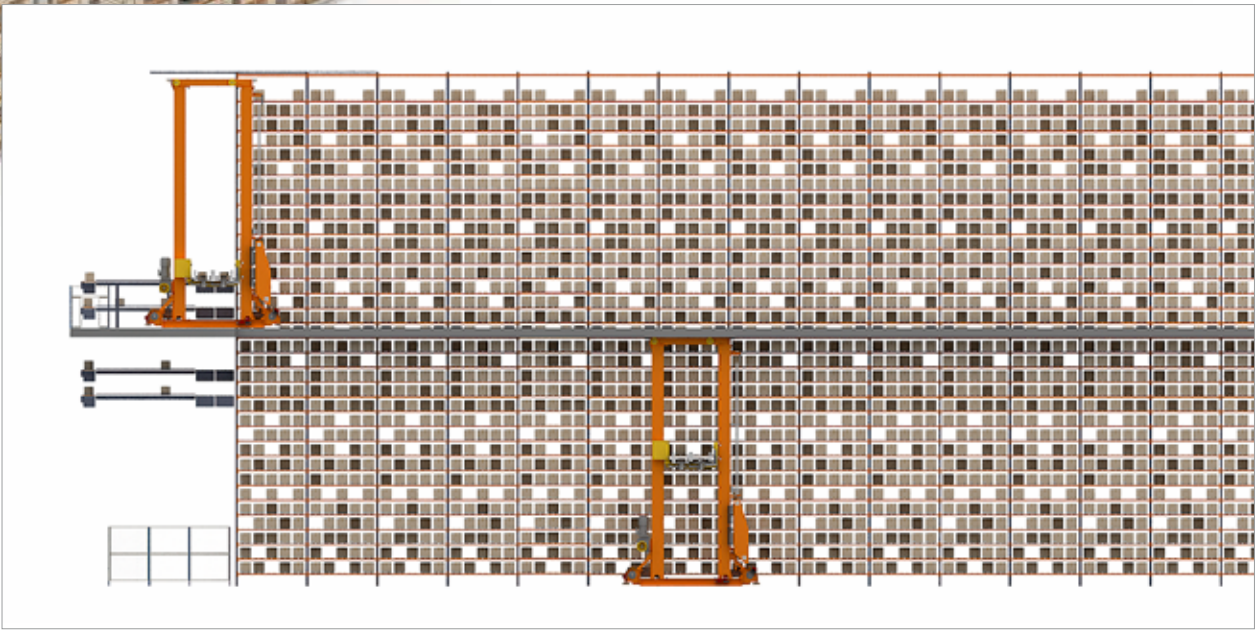

Lateral view of the warehouse, with two stacker cranes in height.



9

Picking and replenishment positions

Each warehouse solution has a specific header solution and, therefore, a particular picking position solution.

With a single aisle, there are two header options: frontal and lateral.

Frontal header

This is a U-shaped circuit located at the end of the racking. The operator carries out the various functions at the front, where the support equipment (screen, barcode reader, confirmation buttons, emergency stop button, control of loading gauge, etc.) is located.

Goods are replenished in the picking position itself.

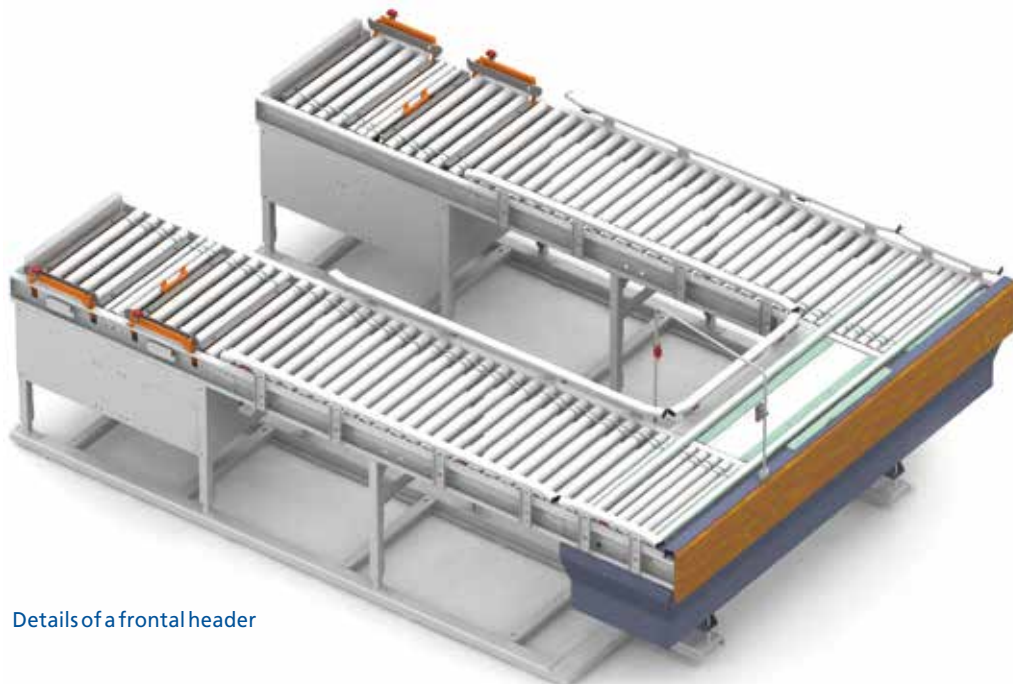

Details of a frontal header



Lateral header

In this case, the circuit is also U-shaped but positioned laterally to the racking.

This solution is ideal when better use must be made of the length available, or when two stacker cranes are working in the same aisle.

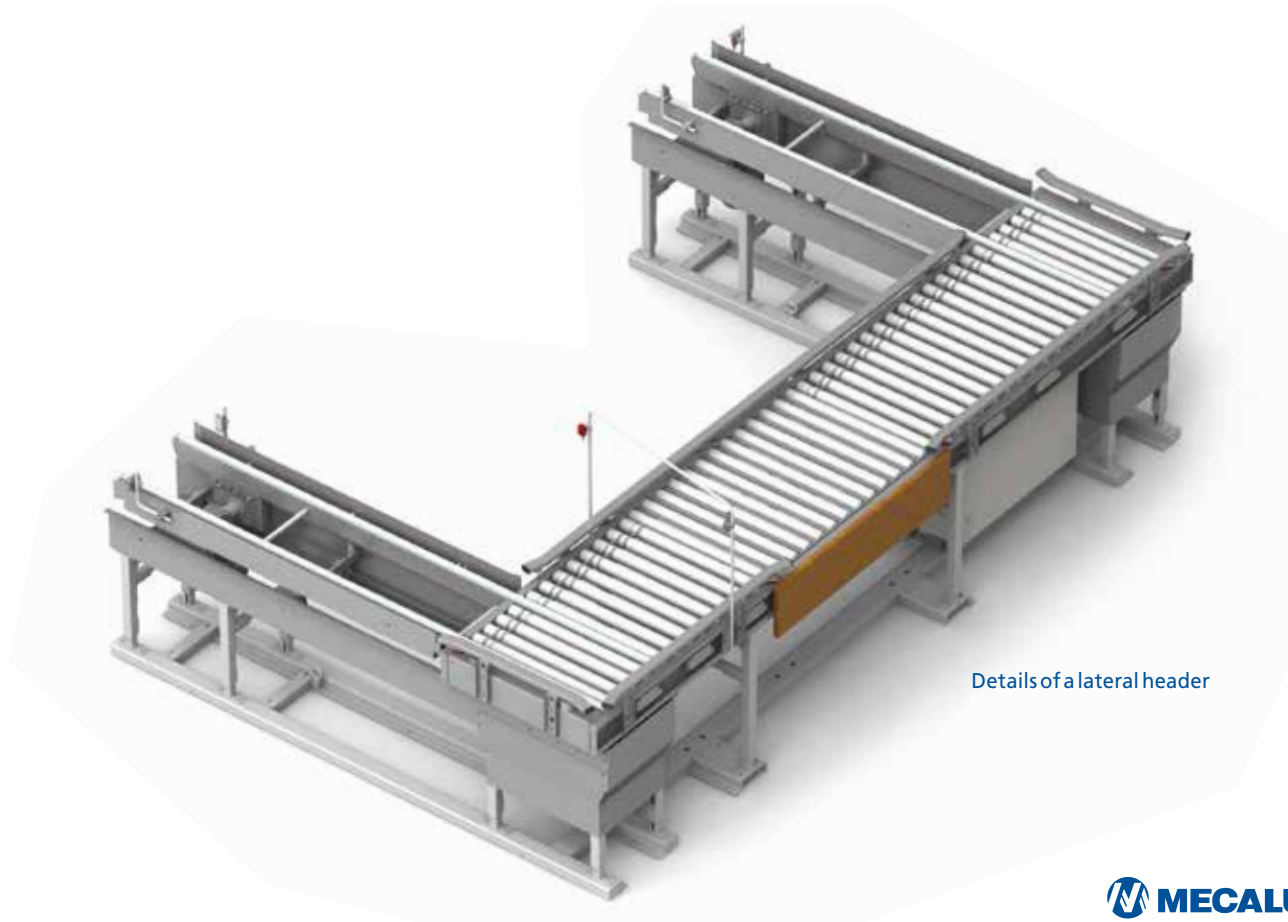

Details of a lateral header

In warehouses with two or more aisles, the number and form of picking positions depend on the number of picking operations to be carried out and on the procedure used in the preparation of orders. This is also true of operations to replenish stock, which can be carried out in the same position or in some other location.

Examples of picking positions:

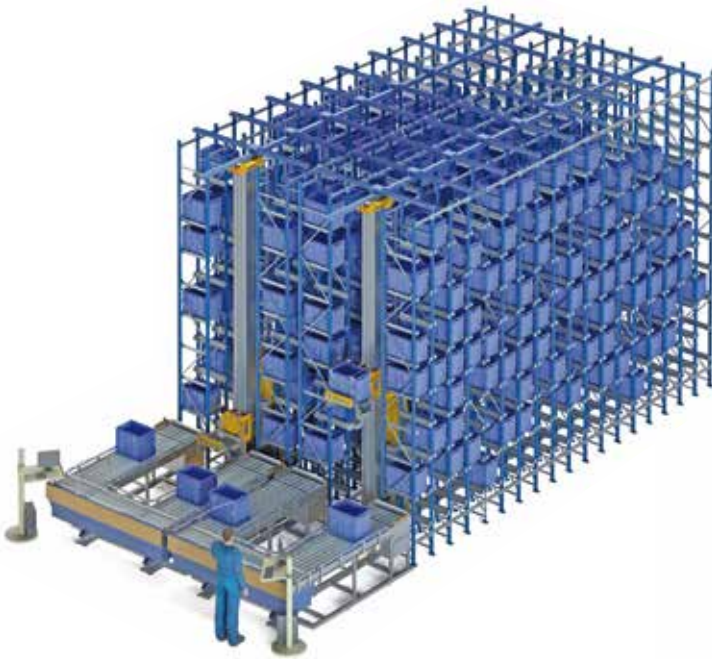

Two aisles and two separate picking positions

In this case, two warehouses with one aisle are combined. Each position only receives boxes stored in one aisle. Working with just one operator is a viable option.

Goods are replenished in the picking position itself.

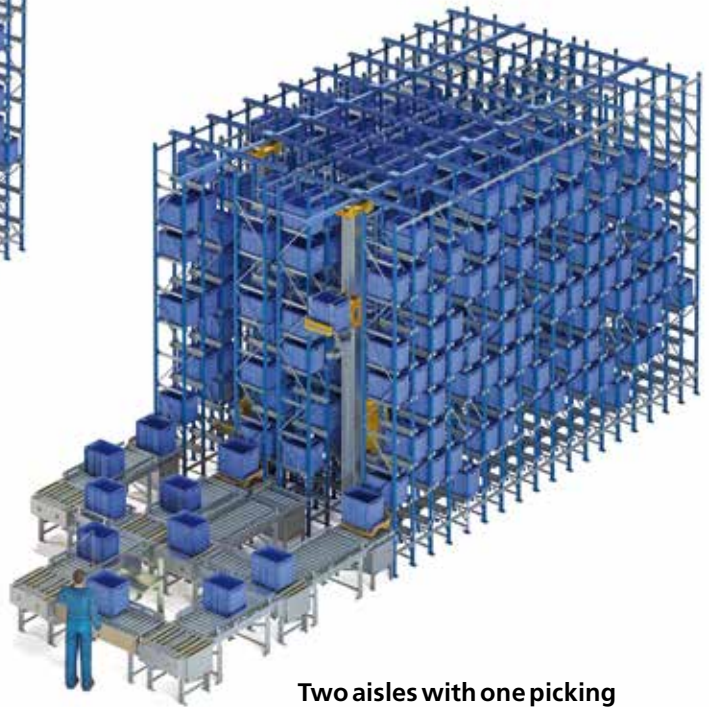

Two aisles with one picking position

A unidirectional cross conveyor belt connects the different input and output conveyors to the picking position. Goods can be replenished in the picking position itself or via an additional conveyor connected to a production centre or replenishment position.

Two aisles and two picking positions

Two cross conveyor belts are installed to allow the inward and outward movement of boxes, both from the aisles and from picking positions.

This solution is only valid if the two stacker cranes can supply the number of boxes required by each operator.

As with the previous solution, goods can be replenished in the picking position itself or via an additional conveyor.

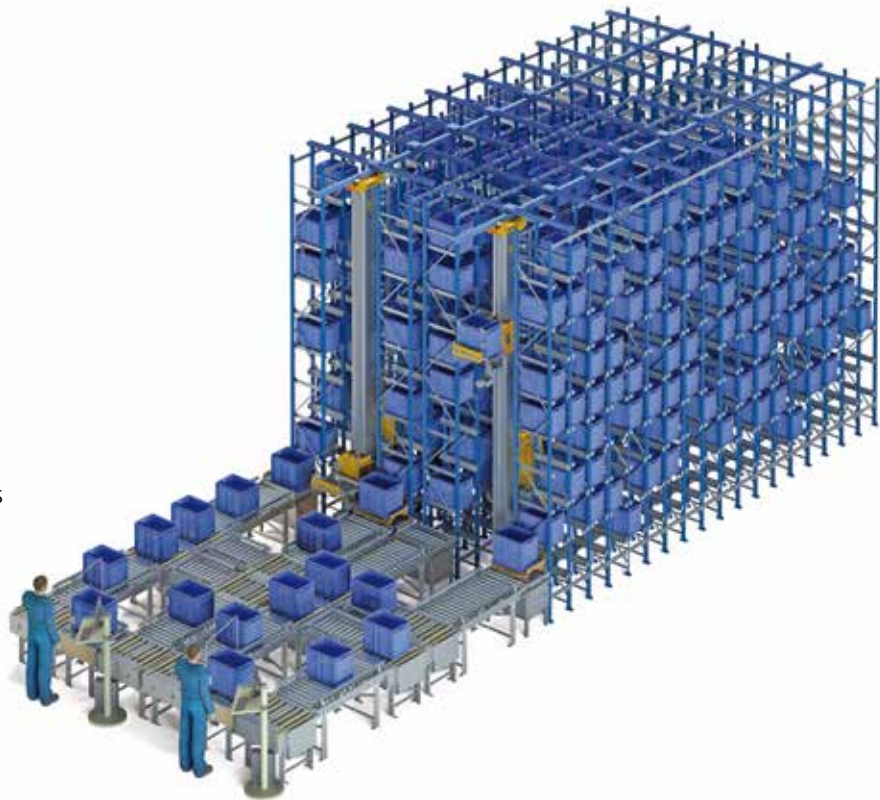

Numerous aisles and numerous picking positions

When there are more than two aisles and more than one picking position, a minimum of two cross conveyor belts are required to connect the input and output conveyors in the warehouse to the picking positions.

A specific position for replenishment operations is also required. This position can be in the same area or in another part of the building connected to the warehouse using roller conveyors.

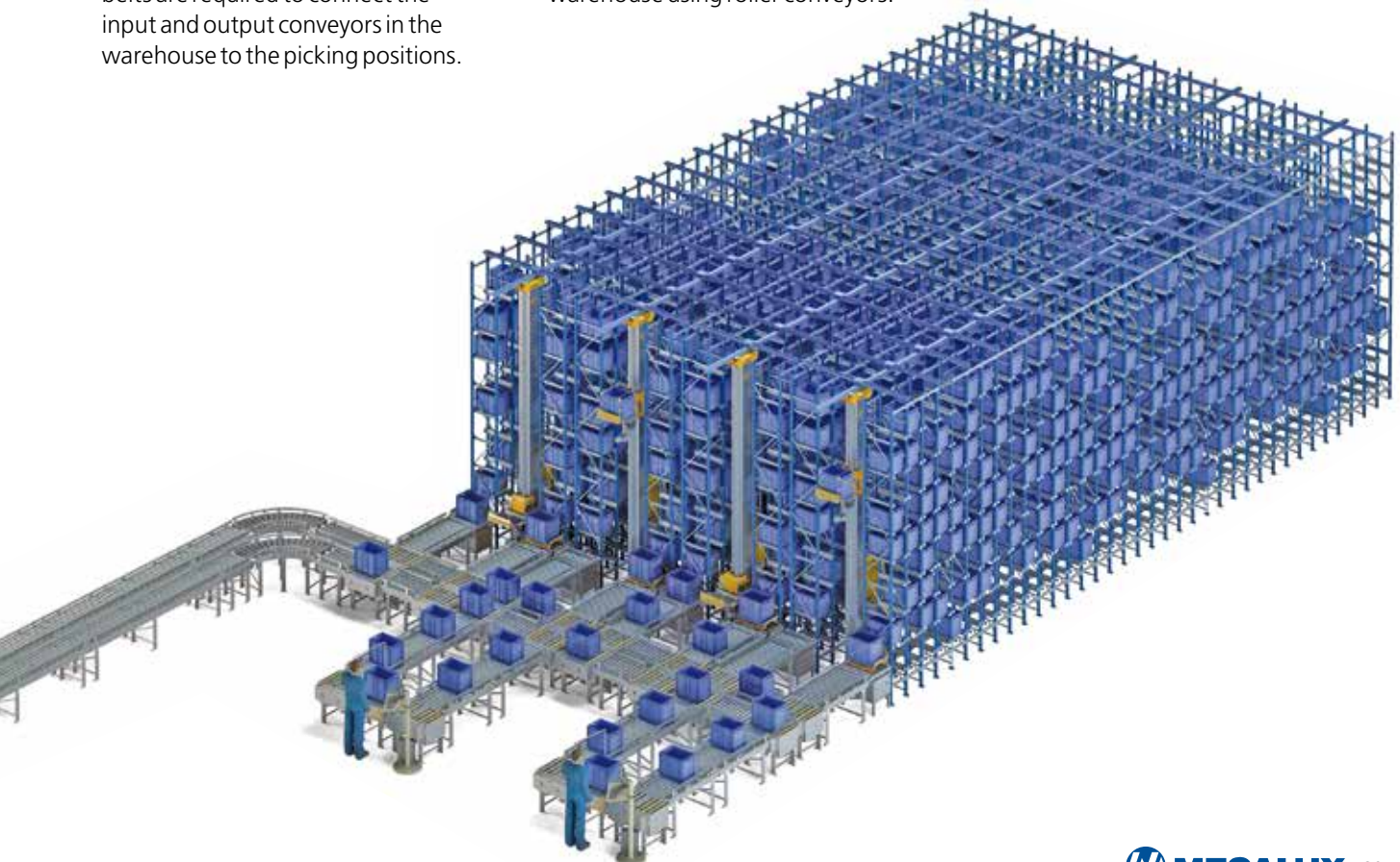



Picking on lateral live storage racking

When a large number of SKUs are accessed on a constant basis, an optimal solution is to install live storage racking on the lower levels, positioned laterally and able to handle a depth of two or more boxes.

The reserve is situated at the top of the warehouse. The stacker crane replaces channels as the boxes are emptied.

Whilst working with this system, pick to light devices and conveyors can be installed. These devices make the work of the operator easier in order to improve their performance.

The image below illustrates a solution with two aisles: one single depth and one double depth. One of the double-depth live storage racking laterals has picking channels and a conveyor, while at the front there is a header with two picking positions for preparing SKUs consumed in smaller volumes.

The repositioning is carried out at an independent point.

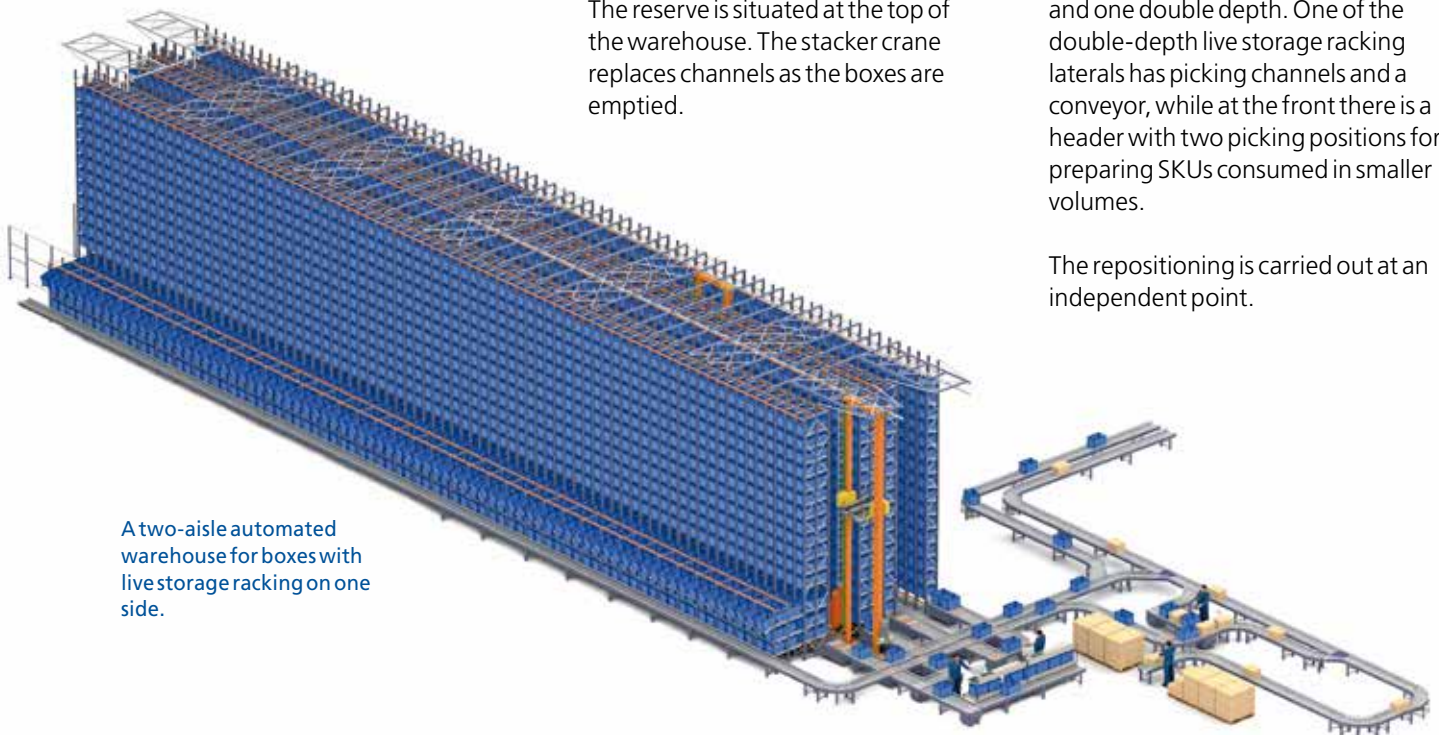

A two-aisle automated warehouse for boxes with live storage racking on one side.

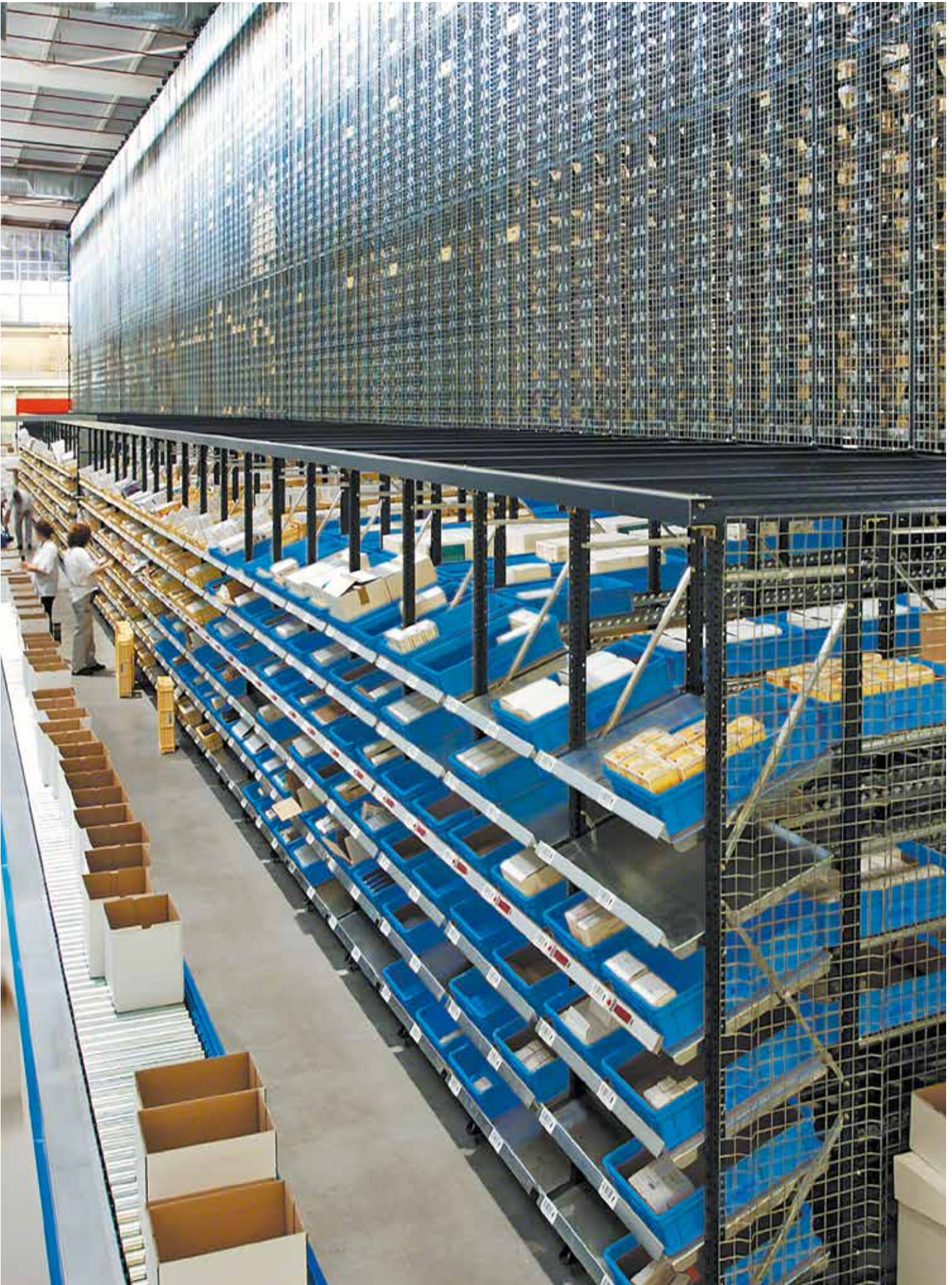

Large-scale frontal picking

How a warehouse operates is determined by the number of picking positions, stacker cranes, lines to prepare, and orders prepared by each operator.

Boxes can arrive at picking positions in an intermittent manner, thereby there is a need for an accumulation conveyor in each position. Nevertheless, said goods may need to arrive in a certain sequence in order to avoid down time in operations. Each warehouse will require a specific project, designed to the requisites of the client.

The example in this illustration shows a warehouse with nine double-cradle miniloads, seven picking positions, a position for replenishing stock from the pallet area, and three conveyor circuits. With this arrangement, boxes destined for picking positions and the warehouse and boxes containing orders that have already been prepared are not mixed together.

A general collector connects this warehouse to other work areas.

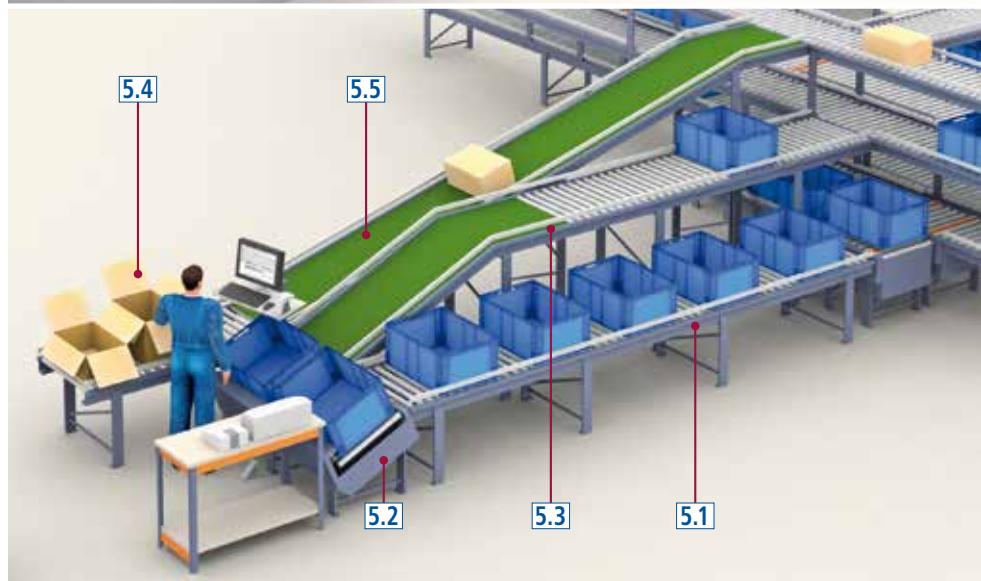
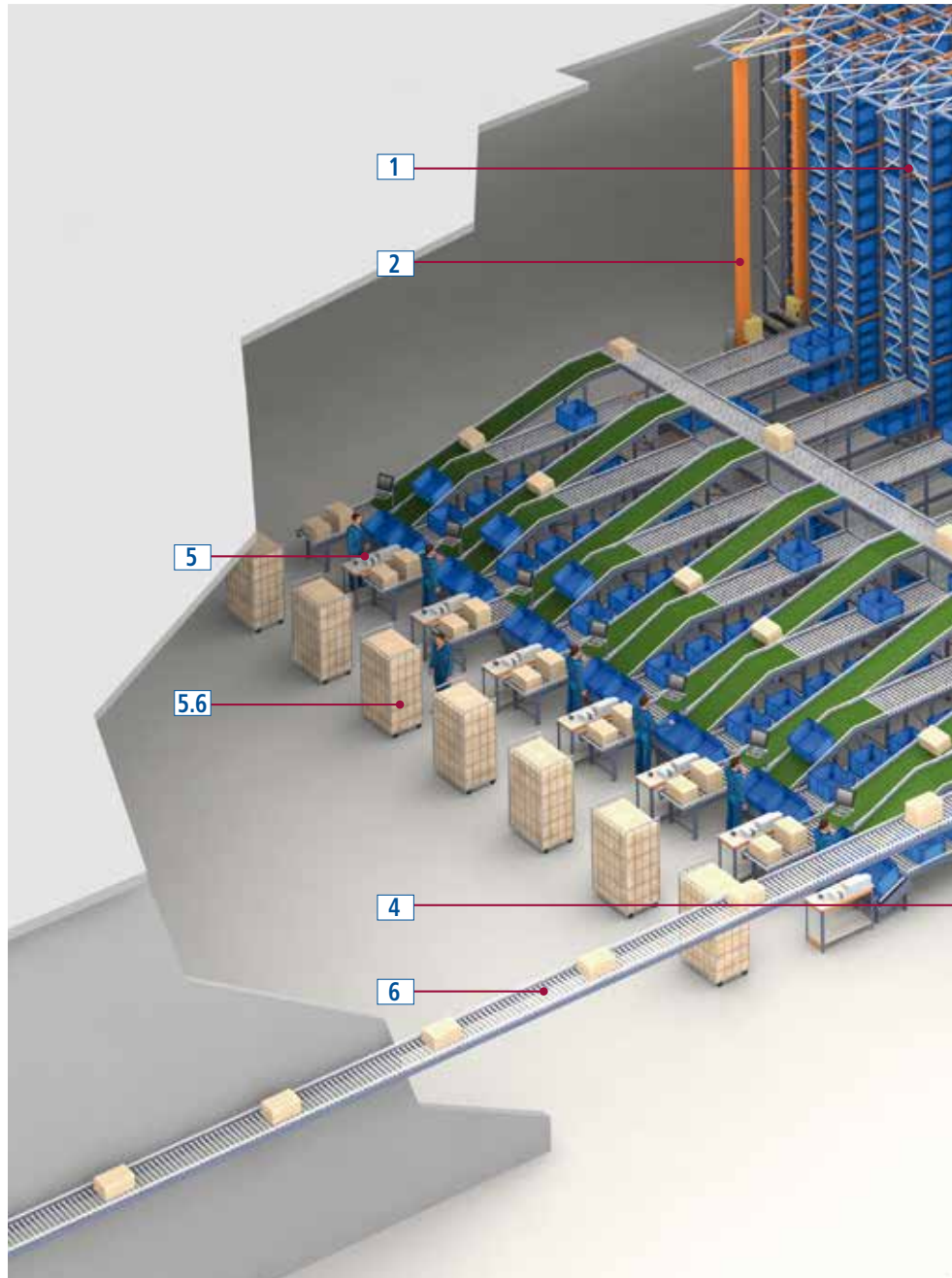

Details of picking position



Warehouse with nine double-cradle miniloads, seven picking positions, a position for replenishing stock from the pallet area, and three conveyor circuits.

- 1. Warehouse for boxes
- 2. Stacker crane
- 3. Box fill position (supply)
- 4. Elevator
- 5. Picking position
 - 5.1. Output conveyor to picking with accumulator
 - 5.2. Semi-detachable ergonomic conveyor
 - 5.3. Return conveyor
 - 5.4. Boxes for orders
 - 5.5. Conveyor for prepared orders
 - 5.6. Boxes made for orders
- 6. Level of conveyors for dispatches



Picking positions in annexed areas

Picking positions can be located in annexed areas, fitting out the space they would occupy if they were located in the front as a warehouse.

This type of solution facilitates future growth, in particular in picking positions. It also doubles the size of the warehouse, leaving the common conveyor area in the middle and each section of the warehouse on both sides.

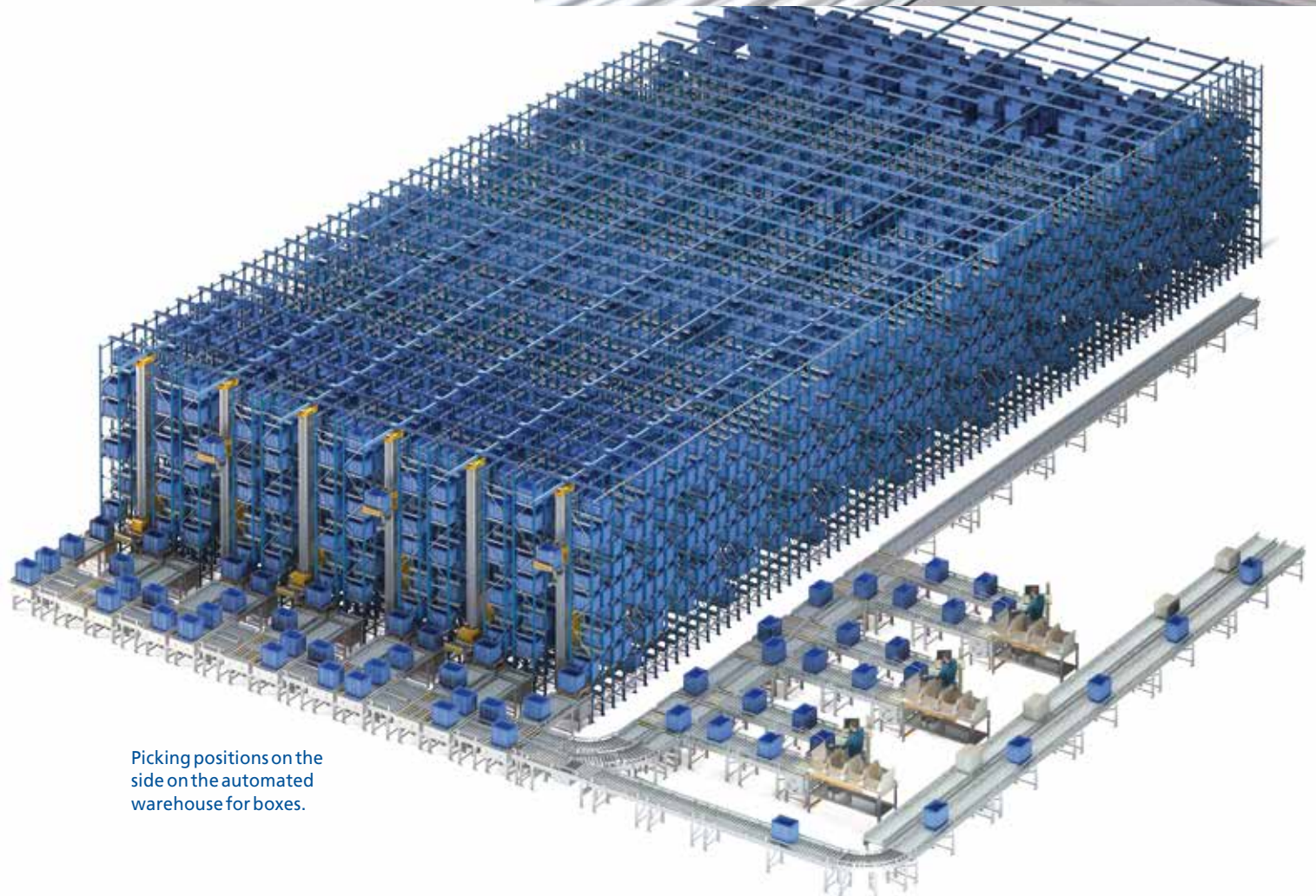

Picking positions on the side on the automated warehouse for boxes.



Picking positions can also be installed in elevated areas. By installing them in elevated areas, the benefits of placing picking positions in annexed areas are retained and best use is made of the height of the warehouse.

The illustration below shows a warehouse with four picking positions on an elevated floor. The lower part is used as a classification and dispatch area. The conveyors on both floors are connected by an elevator.

1. Automated warehouse for boxes
2. Stacker crane
3. Picking positions
4. Elevator
5. Classification area

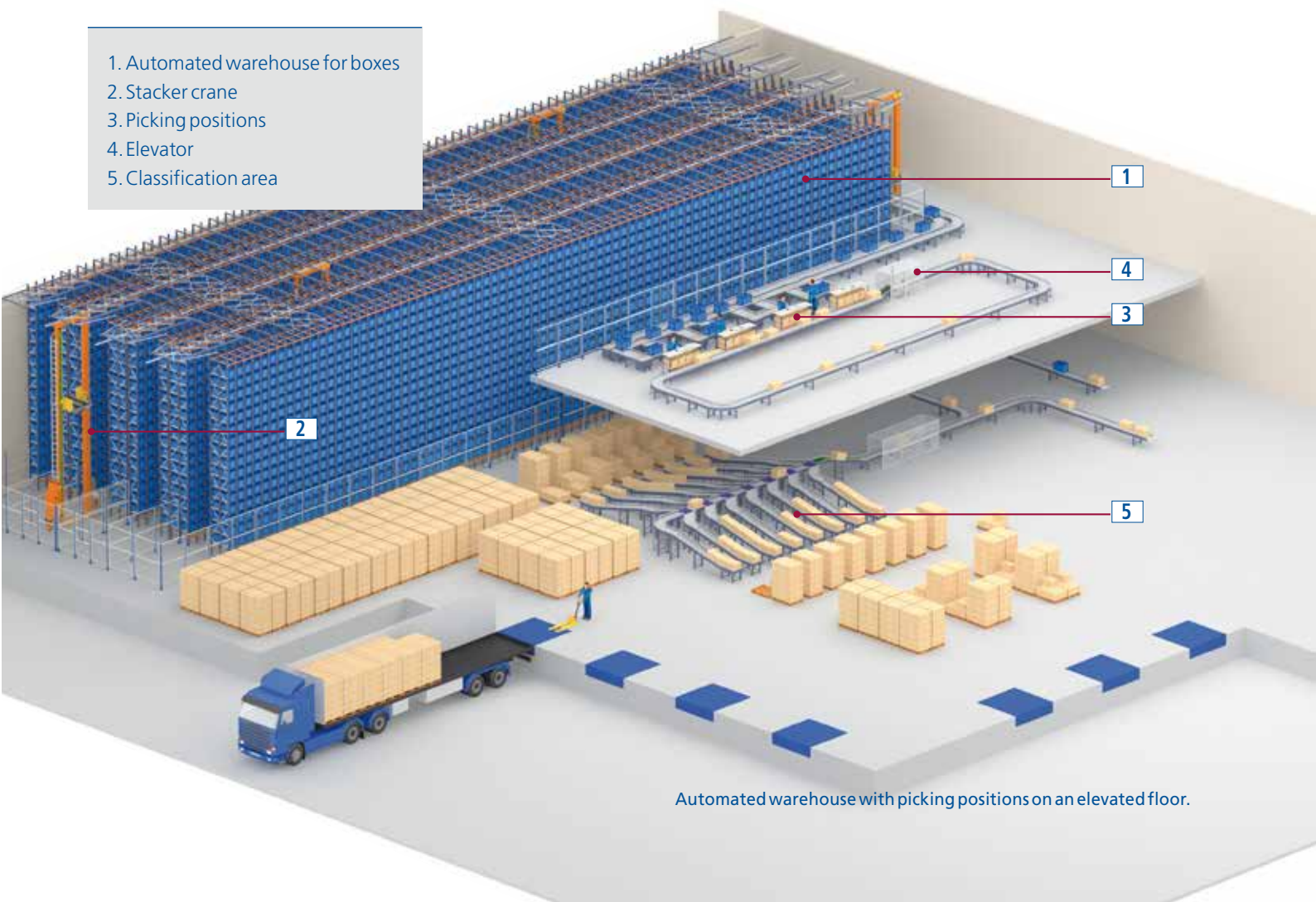

Automated warehouse with picking positions on an elevated floor.



Automated warehouse for boxes to supply a sorter

The example seen in this illustration, a warehouse for cardboard boxes operated by 12 double stacker cranes, allows cardboard boxes to be stored directly with their goods inside. This is common in the textile and accessories sector.

When the time is right, the cardboard boxes are sent to the picking positions. The product is then extracted from inside the boxes and deposited loose in a classification sorter with accumulation cells. Each cell relates to an order, with the goods deposited automatically into the appropriate cell.

In this case, the sorter is a never-ending circuit of shuttles that form a chain. Each shuttle has a mobile horizontal band that, at precisely the right moment, moves the goods left or right to deposit them in the appropriate cell.



Support equipment helps make the work of the various operators involved easier.

Orders prepared in the cells of the sorter are inserted into cardboard boxes, which are sent to the sealing and control section on the conveyors. Finally, these boxes are sent to the route classifiers installed in the dispatch bays.

For more information on sorters, go to pages 50-53.

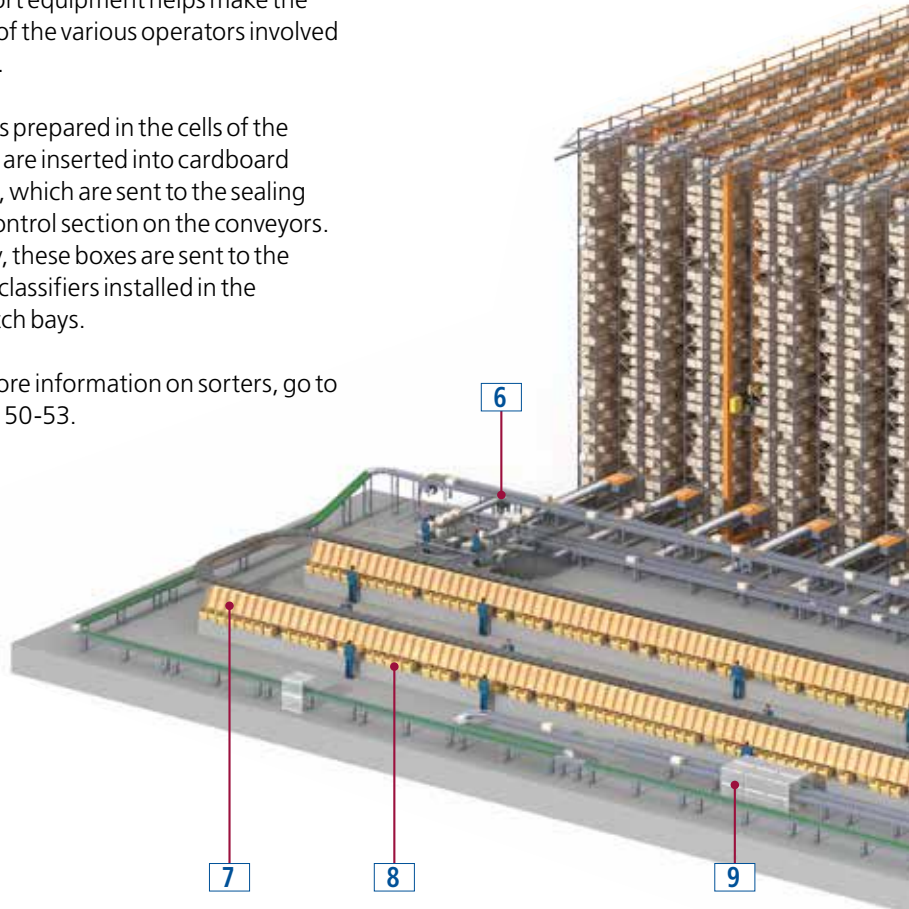

1. Receipt of goods
2. Extendable conveyor
3. Quality control and reconditioning
4. Automated warehouse for boxes with stacker cranes
5. Box conveyor circuit
6. Area for insertion of individual units
7. Order classification sorter
8. Cells for the preparation of orders
9. Sealing and control section
10. Supply of empty boxes
11. Route classification
12. Dispatches

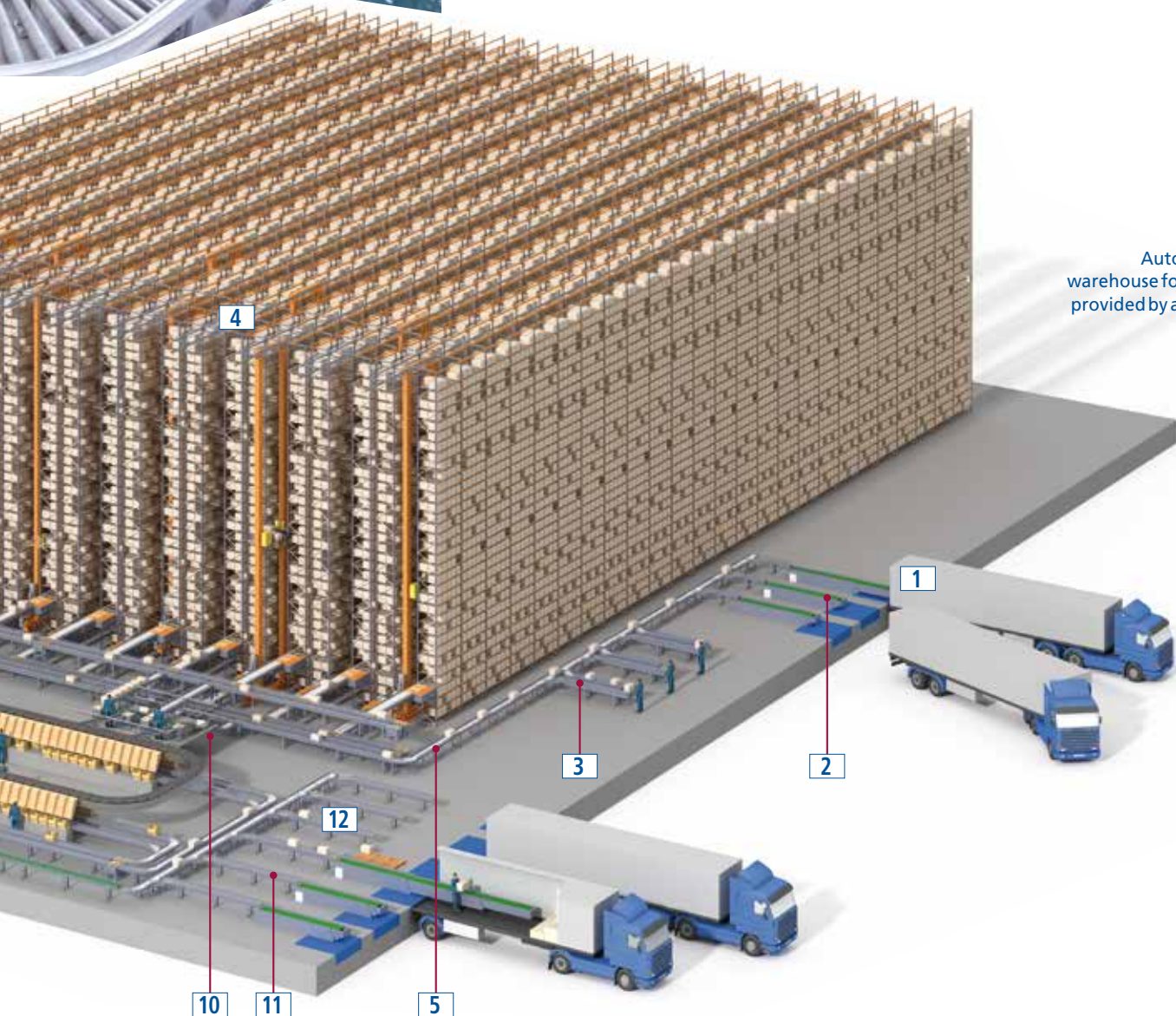

Automated warehouse for boxes provided by a sorter.

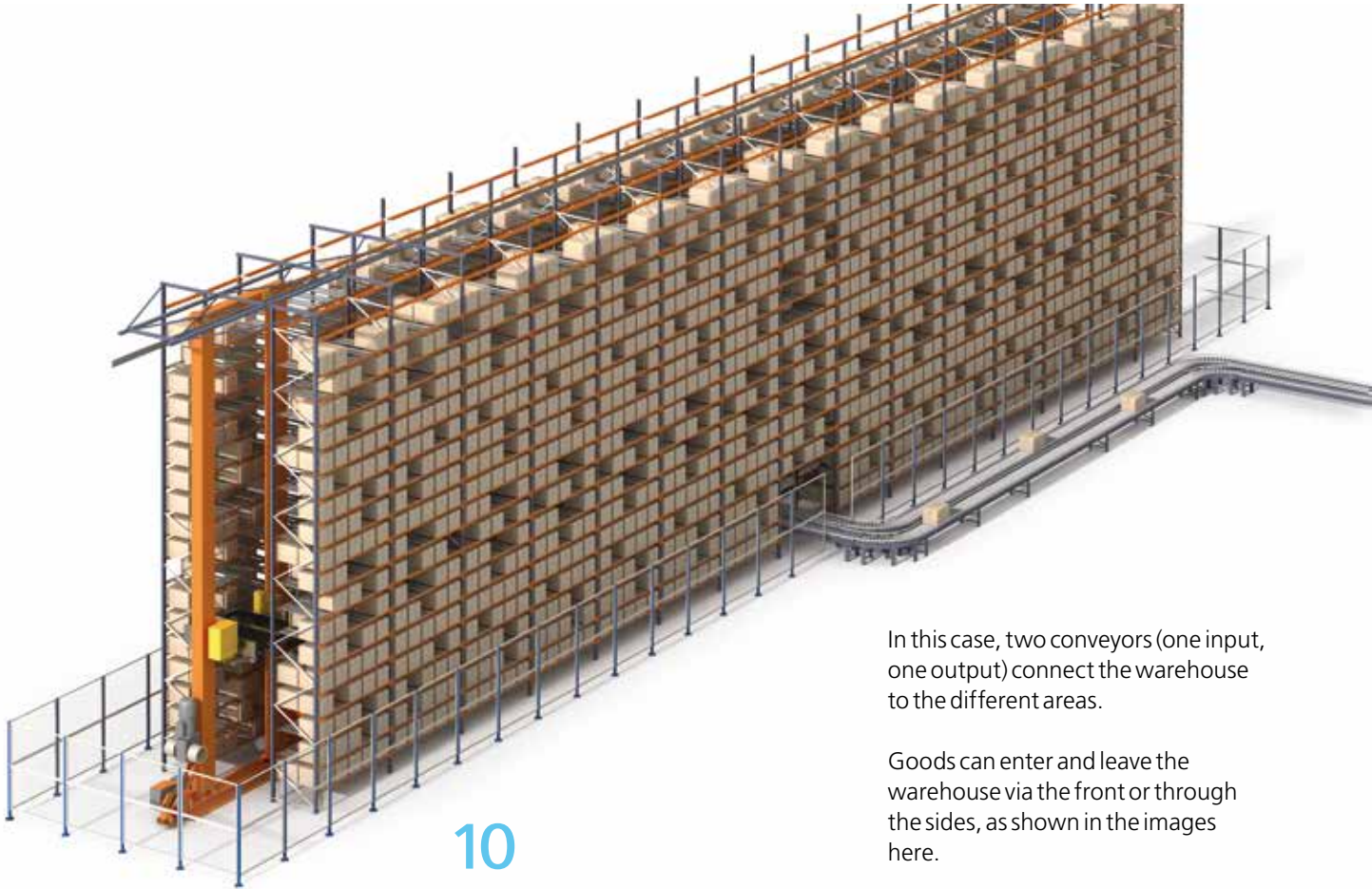

Automated warehouse for cardboard boxes with side entrance and exit.

10 Role as buffer

Miniloads can be warehouses that regulate between different production areas, provided that they handle complete units. There are no picking positions.

In this case, two conveyors (one input, one output) connect the warehouse to the different areas.

Goods can enter and leave the warehouse via the front or through the sides, as shown in the images here.

Any type of stacker crane can operate in a warehouse that acts as a buffer. However, those used most frequently are high-performance stacker cranes, which can also be used as sequencers.

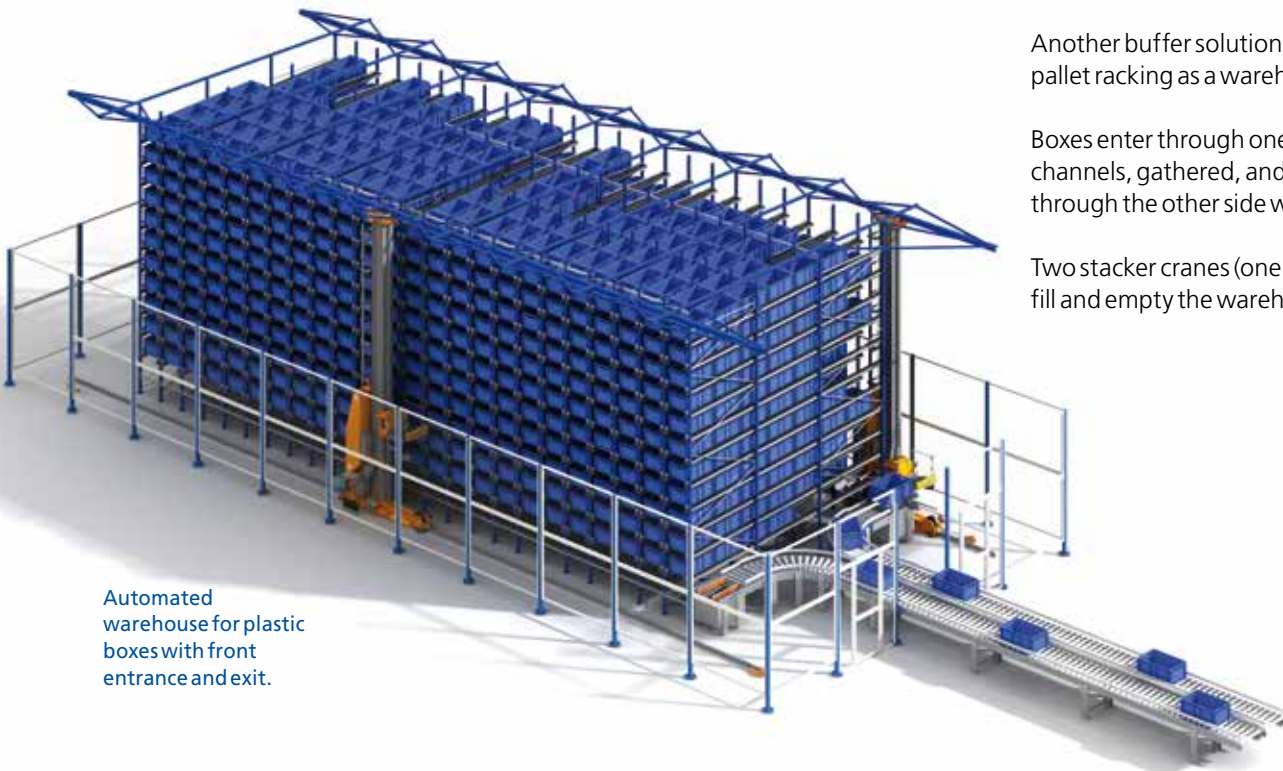

Automated warehouse for plastic boxes with front entrance and exit.

Another buffer solution is to install live pallet racking as a warehouse.

Boxes enter through one side of the channels, gathered, and are extracted through the other side when required.

Two stacker cranes (one on each side) fill and empty the warehouse.



11

Working temperatures

Some products require controlled temperatures, with some requiring even temperatures below 0°C (freezing chamber).

In these cases, the warehouse is insulated to prevent a loss of temperature and, therefore, saving energy.

In temperatures below zero, picking positions are located in annexed areas.

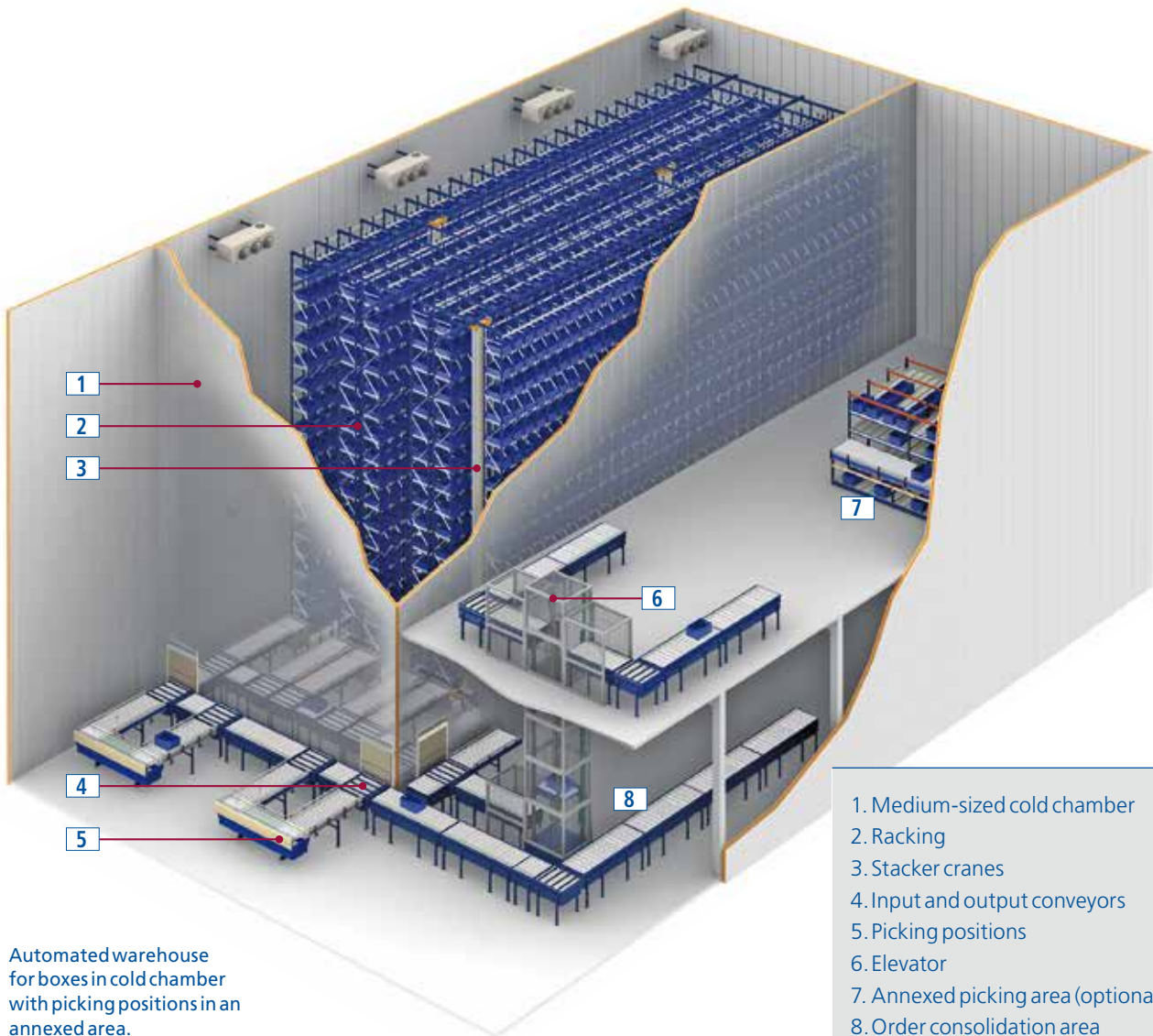

Automated warehouse for boxes in cold chamber with picking positions in an annexed area.

- 1. Medium-sized cold chamber
- 2. Racking
- 3. Stacker cranes
- 4. Input and output conveyors
- 5. Picking positions
- 6. Elevator
- 7. Annexed picking area (optional)
- 8. Order consolidation area



Miniload combined with different load units and diverse warehouse systems.

12

Combination with other warehouse systems

Different goods and load units that require particular treatment can be kept in a single warehouse.

Furthermore, there can be great variation in the rate of consumption of these goods. As a result, the procedure will require a different application in each case.

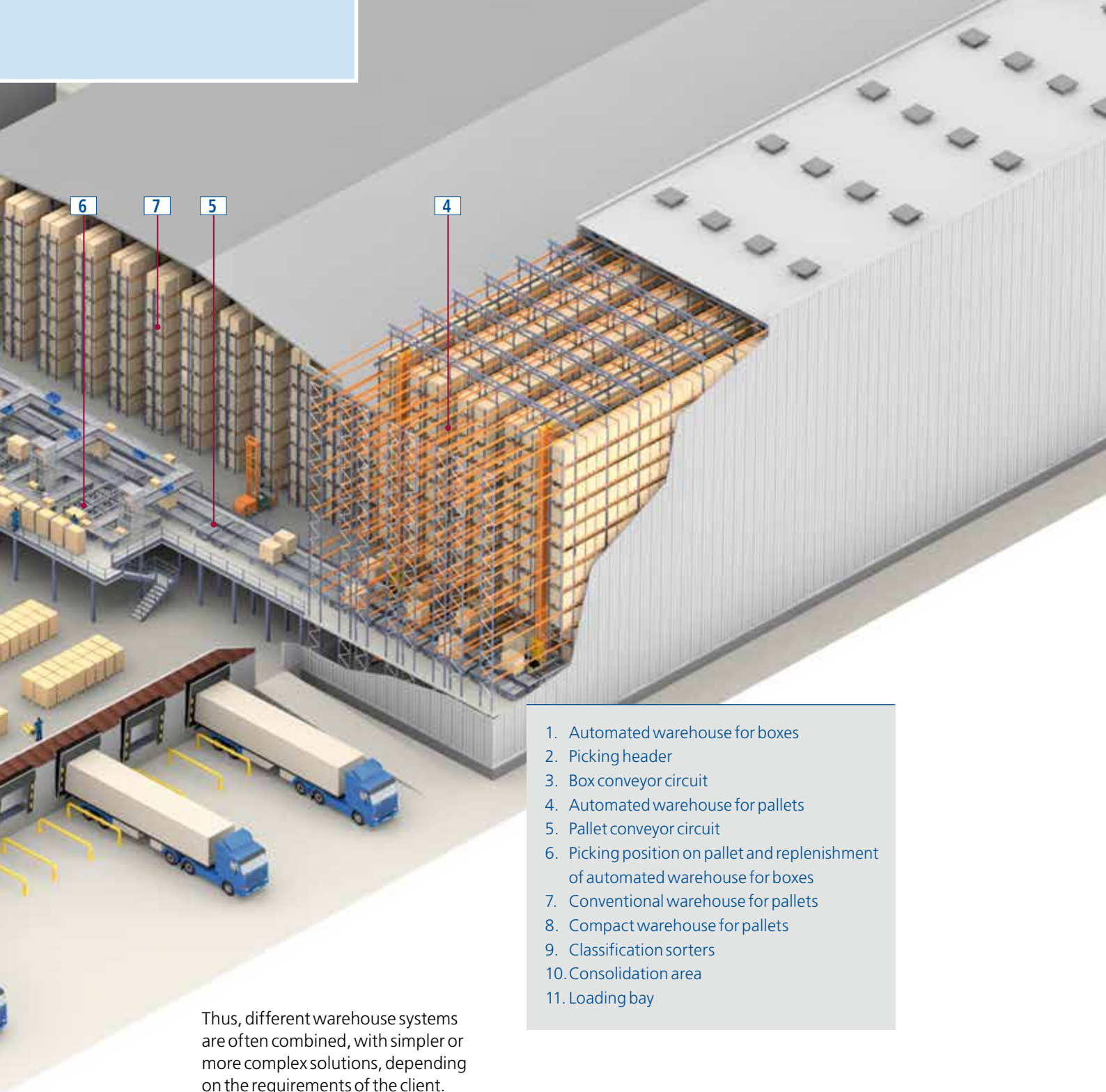

1. Automated warehouse for boxes
2. Picking header
3. Box conveyor circuit
4. Automated warehouse for pallets
5. Pallet conveyor circuit
6. Picking position on pallet and replenishment of automated warehouse for boxes
7. Conventional warehouse for pallets
8. Compact warehouse for pallets
9. Classification sorters
10. Consolidation area
11. Loading bay

Thus, different warehouse systems are often combined, with simpler or more complex solutions, depending on the requirements of the client.

Example 1

In this example, there is an automated warehouse for boxes incorporated into a larger warehouse. It consists of a compact pallet storage area for products of mass consumption, a conventional racking unit area served by trilateral turret trucks to store varied medium-sized goods, which allows orders to be prepared directly on the pallet or whole pallets to be dispatched, and an automated

warehouse for pallets for reserve and large products. In addition, these areas have order preparation and replenishment areas and a conveyor circuit, a classification sorter, a consolidation area, and loading bays.

It also has Easy WMS warehouse management software, which manages all areas of the warehouse in an integrated manner.



Example 2

In this example, there is an automated warehouse for boxes integrated with other picking warehouses (one with conventional racking and another with live pallet racking). All are connected by a circuit of box conveyors and elevators that, in turn, is connected with pallet conveyors and depalletising posts, one of which is fully automated.

"A" products (products with high levels of consumption), "B" products (medium level of consumption) and "C" products (those consumed in small volumes) are stored in a single warehouse. According to the 80/20 principle (80% of consumption volumes is accounted for by 20% of SKUs, while the other 20% of consumption is accounted for by the other 80% of SKUs), close to 15% of SKUs could be "A" products, 35% "B" products, and 50% "C" products. Thus, according to what is stated here, it is logical to store each

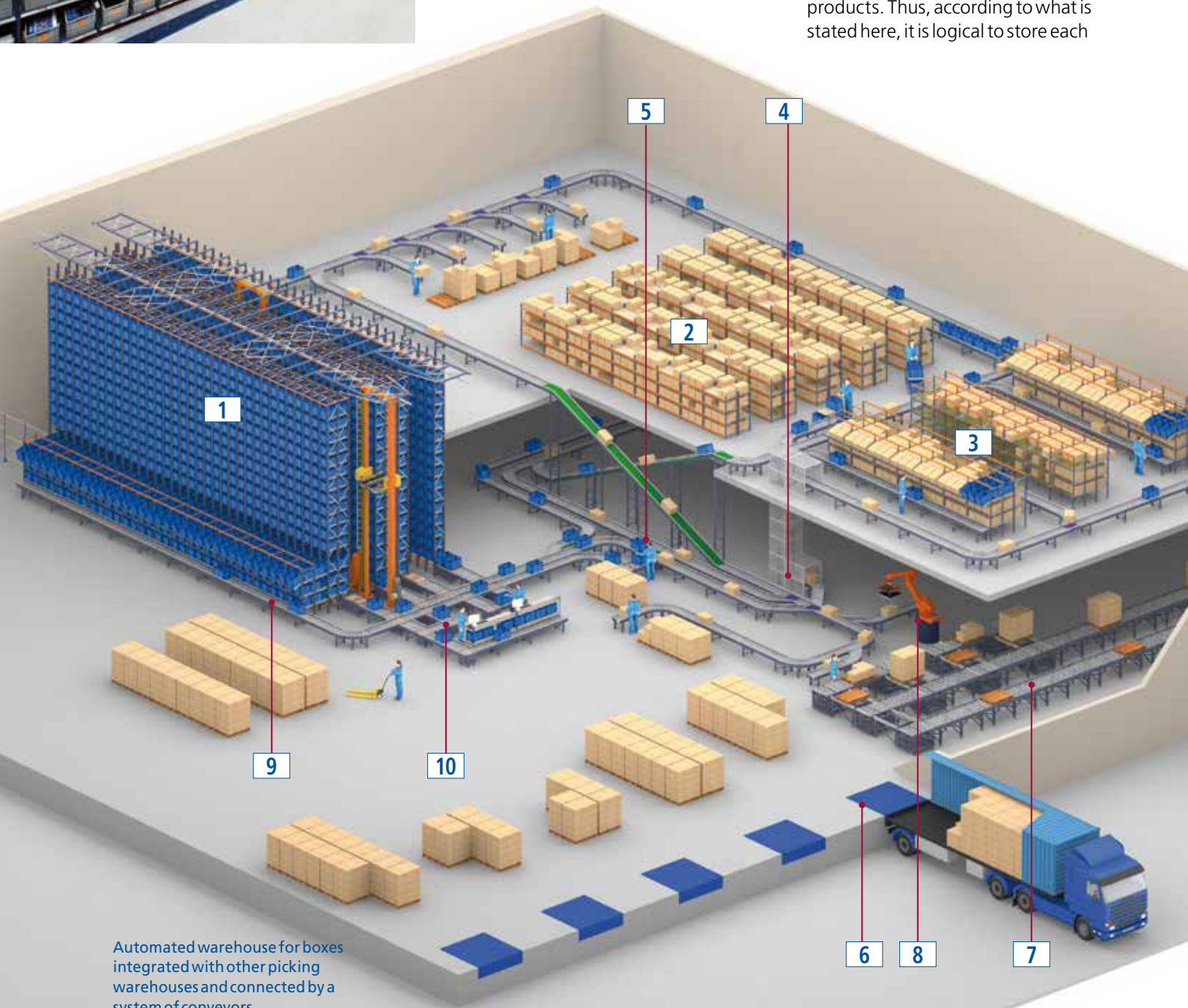

Automated warehouse for boxes integrated with other picking warehouses and connected by a system of conveyors.

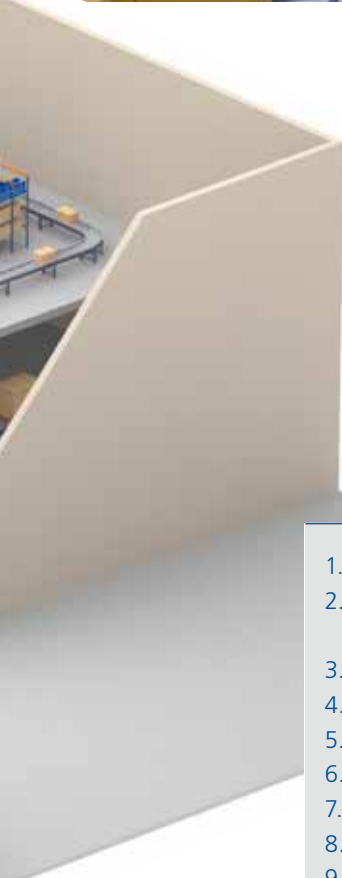

type of product with a different storage system, where the size of the warehouse so allows.

In the example in the image on the left, "A" products would be stored on live pallet racking, possibly using pick to light systems to improve performance, as this would result in more lines for the preparation of orders. "C" products would be on the conventional picking racking,

while "B" products would be located on the miniloads.

A number of "B" products can be extracted frequently and, while they are not "A" products, it could be beneficial to store them in this system. For these products, there are sideways live pallet channels that facilitate picking. All other products are extracted from normal picking positions in the header.

When orders are prepared in different areas, there is a consolidation area. It is important to analyse how goods are sent from reception areas as well as from preparation areas. In this example, they are sent on roller or band conveyors, as well as vertical elevators that connect the two floors.

1. Automated warehouse for boxes
2. Conventional picking warehouse (operated using shuttles with IT support equipment)
3. Live pallet picking warehouse with pick to light
4. Automated conveyor circuit and box elevation
5. Quality control
6. Unloading bay
7. Automated pallet conveyor circuit
8. Depalletiser (automatic and manual)
9. Lateral picking in automated warehouse for boxes
10. Picking in the header of the automated warehouse for boxes



Example 3

In this example, there is a warehouse in which products have been divided into different areas. The most appropriate system is chosen based on the dimensions and typology of the product, the quantity to be stored, and picking and safety requirements.

Each area of the warehouse is strategically located, depending on the flows of movements and the size of the product.

There are various conventional warehouse systems and three automated warehouse systems. The latter includes a self-supporting warehouse for pallets, which has a picking position, and a single

1. Automated warehouse for boxes
2. Automated warehouse for pallets
3. Irregular large goods
4. Warehouse for reels
5. Warehouse for bulky goods
6. Profile warehouse
7. Battery charging for turret trucks
8. Reception area
9. Consolidation area
10. Loading and unloading bay



depth miniload with a lateral picking position for medium-sized products.

Orders are consolidated in a common area used by the three systems to later send them to the appropriate dispatching channel, depending on the order or route.

The Mecalux Easy WMS management software program controls all functions performed in any part of the warehouse.

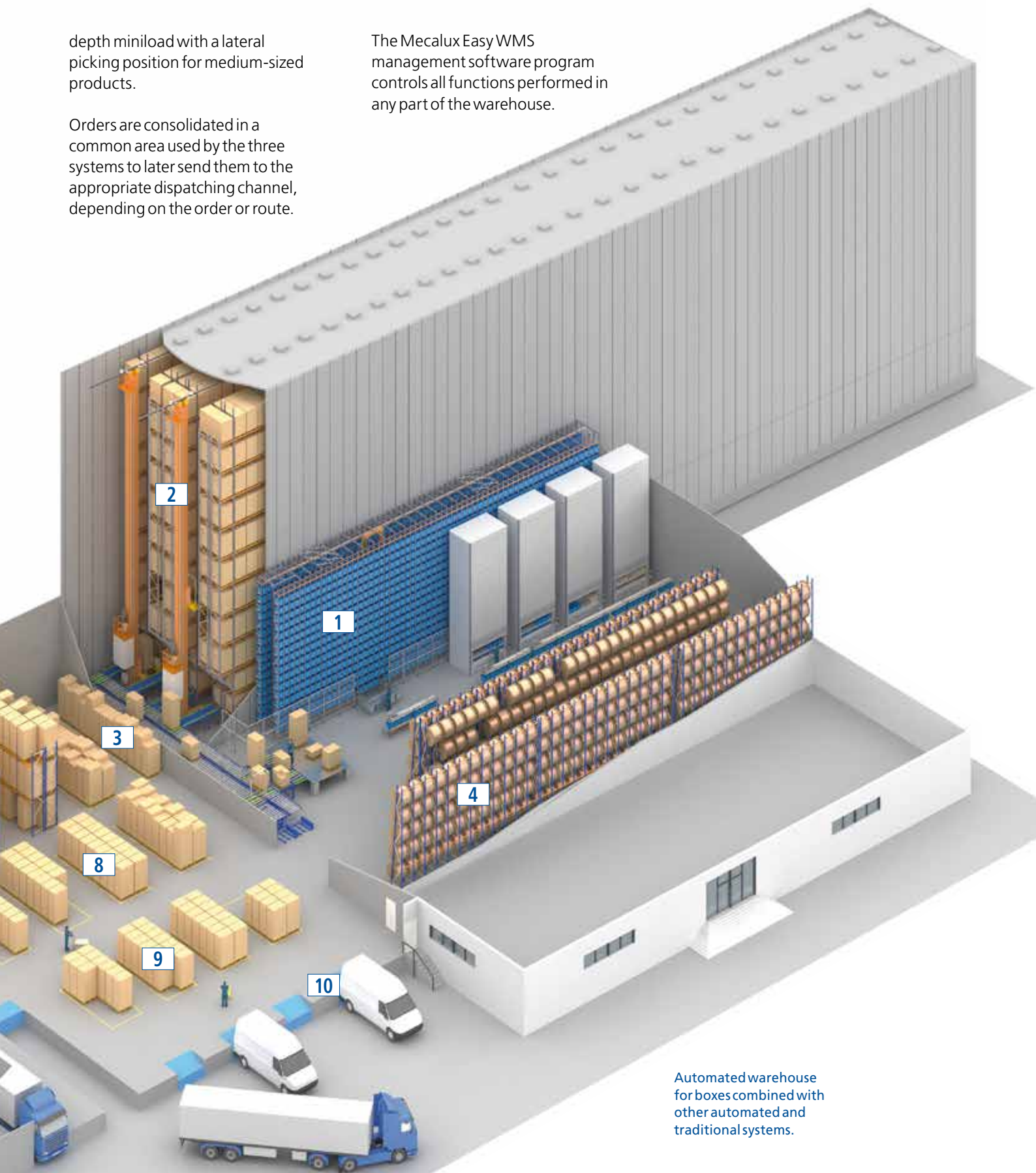

Automated warehouse for boxes combined with other automated and traditional systems.

Example 4

In this example, there is another possible solution for an automated warehouse for boxes combined with live pallet racking and an order sorter.

“B” and “C” products are located in the automated warehouse, while “A” products are positioned in live pallet warehouse. The products prepared in both areas are automatically carried to an order sorter, where they are consolidated and identified by operators.

Live pallet racking incorporate pick to light systems for the paperless preparation of orders, and roller conveyors to facilitate the preparation and transportation of the boxes.

There is a position for replenishing orders for the automated warehouse for boxes in an area separate from the picking positions, with direct exits for empty boxes and an input conveyor to the header.

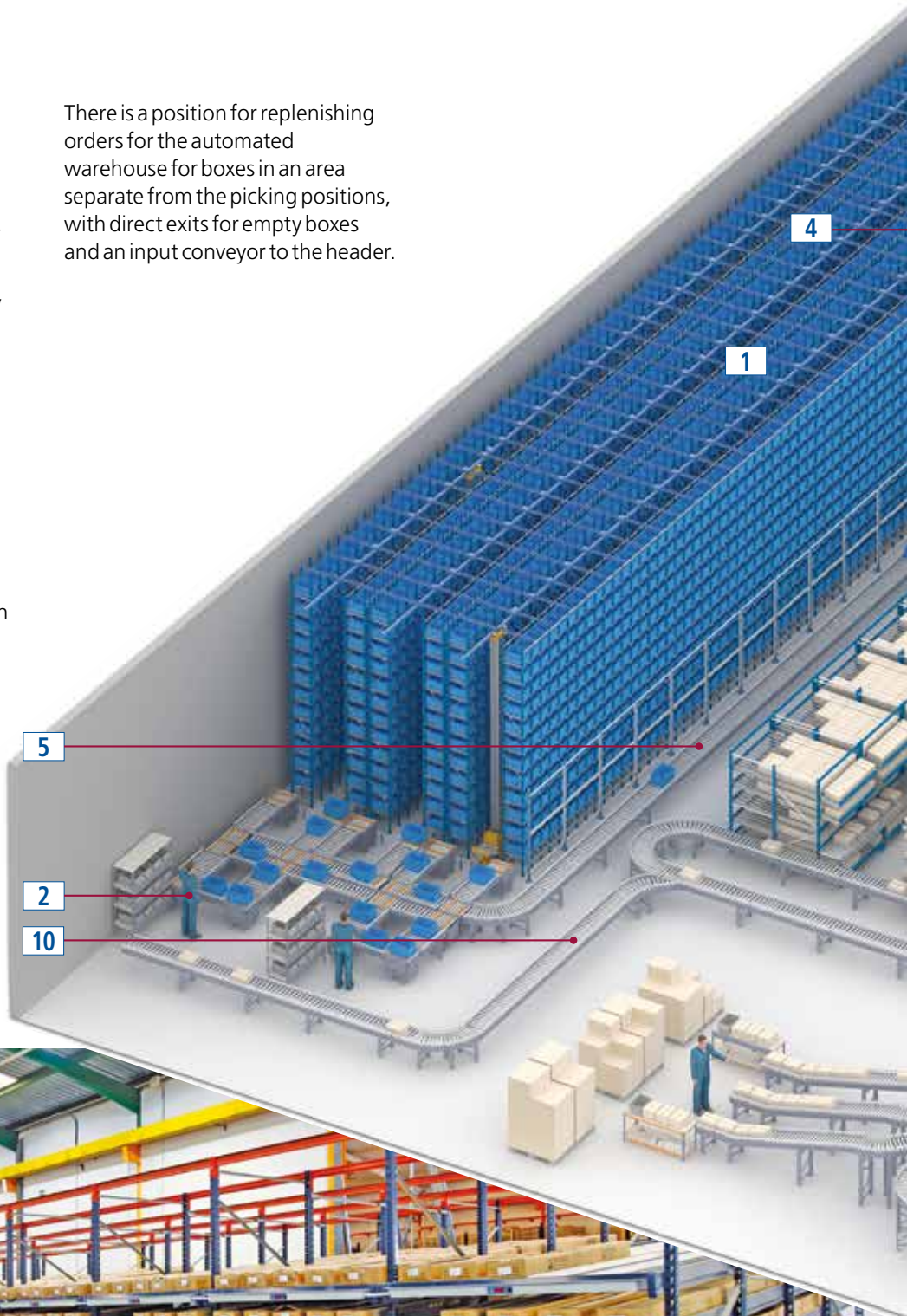

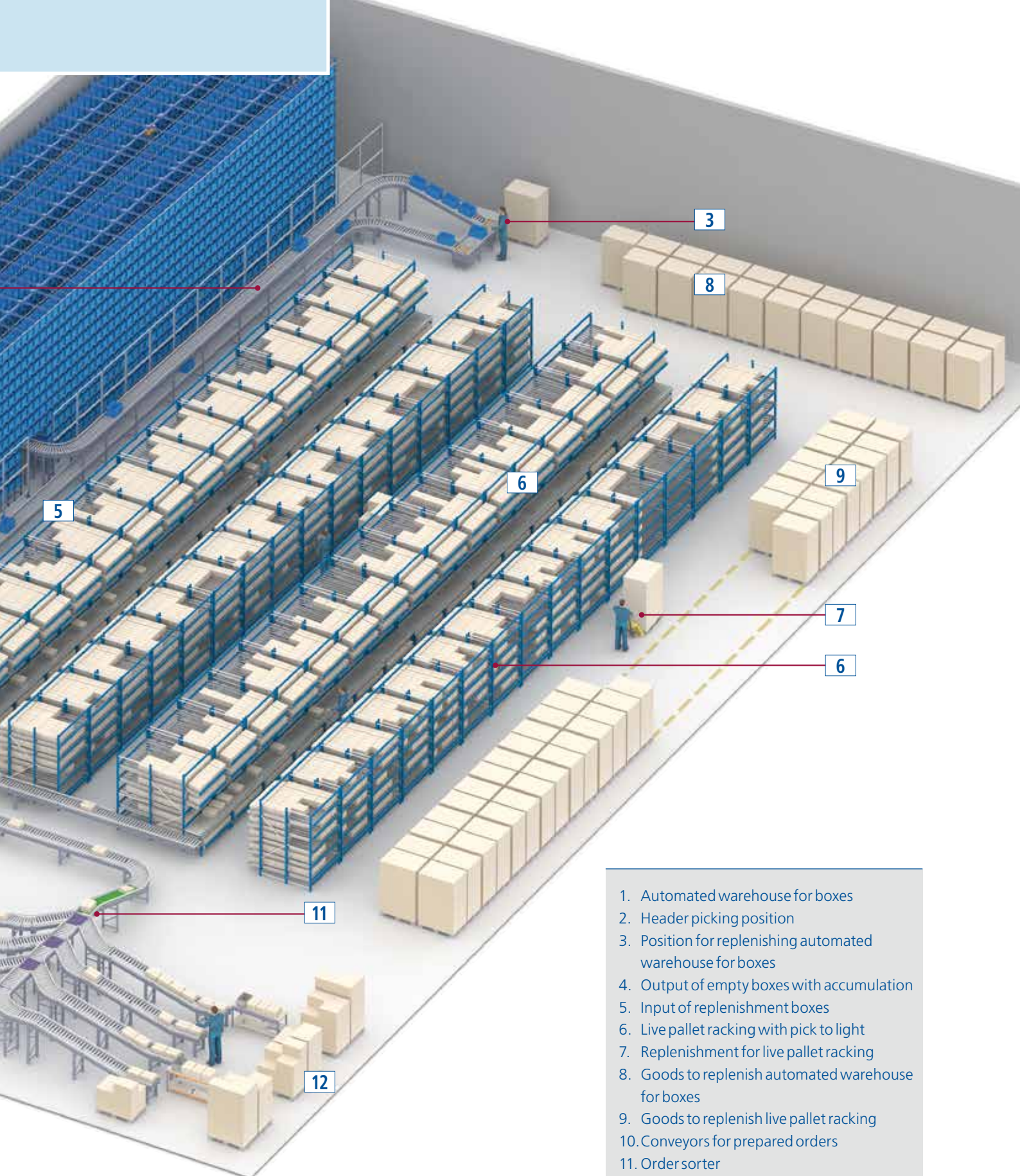

Automated warehouse for boxes combined with live pallet racking and an order sorter.

1. Automated warehouse for boxes
2. Header picking position
3. Position for replenishing automated warehouse for boxes
4. Output of empty boxes with accumulation
5. Input of replenishment boxes
6. Live pallet racking with pick to light
7. Replenishment for live pallet racking
8. Goods to replenish automated warehouse for boxes
9. Goods to replenish live pallet racking
10. Conveyors for prepared orders
11. Order sorter
12. Consolidation of orders



13

Support equipment for the preparation of orders

There are different support equipment for the preparation of orders. The most common of these are as follows:

Preparation of orders with the 'pick to light' system

This is an automated system built into the WMS (warehouse management system) for the paperless preparation of orders.

On the racking unit or levels there are digital screens that light up, indicating the number of units to be extracted if the order to be prepared contains a product in that location.

The operator follows the instructions on the screen and once the extraction of that SKU has completed, presses the confirmation button that turns off the light and validates the picking action.



This system speeds up the preparation of orders and significantly reduces the number of errors made.

This system is often found in automated warehouses for boxes, in particular at the side exits of the live pallet picking system.



Preparation of orders with the 'put to light' system

This is the same system as pick to light, but goods are deposited in the position where the digital screen is illuminated. In general, goods are deposited in fixed picking position when a number of orders are being prepared at the same time.

Shuttles with 'put to light' systems

It is common to combine them in high-performance picking positions, or when a number of orders are being prepared at the same time, starting at live pallet racking where pick to light systems and shuttles go along with put to light systems.

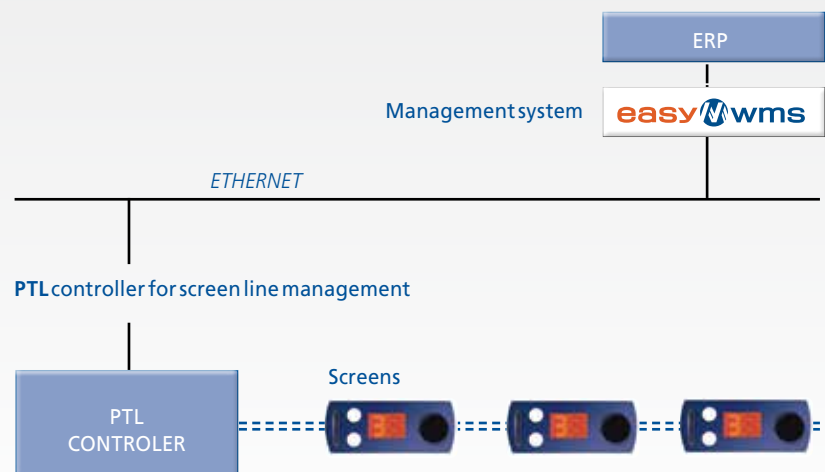

Shuttles with put to light systems can carry a number of orders at once. An electronic controller connected by radio frequency to the WMS computer transmits the different signals.

This system allows orders on conventional racking and on live pallet side racking in automated warehouses for boxes.

14

Automatic classification sorter

In the previous pages, we saw different ways of preparing orders, collecting products from within a box and putting them in a pigeon hole or a box for the preparation of orders. With these systems, there is a given number of preparation lines determined as a function of the system chosen and the support equipment available.

When a large number of orders needs to be prepared at the same time, more agile systems such as the cross-belt classification sorter are

required. These are shuttles joined together that form a never-ending chain on a closed circuit. Each shuttle carries one unit, which is unloaded into a particular cell that contains all products for a single order. Thus, the tables used to prepare orders become the positions where goods are loaded into the sorter.

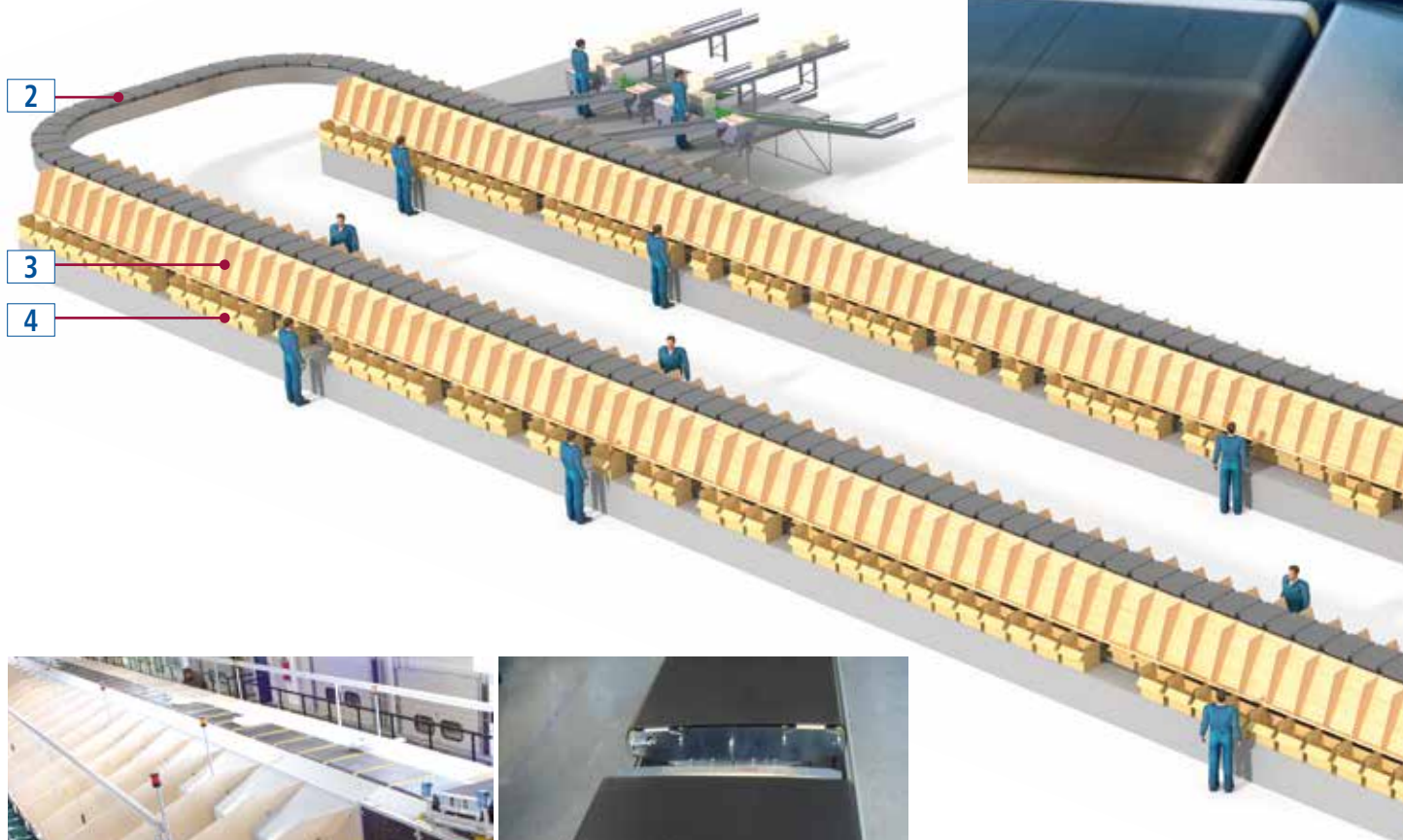

Side view of classification cells



Details of a shuttle



1. Loading positions
2. Sorter circuit
3. Classification cells
4. Packing boxes
5. Box conveyors

Horizontal sorter

There are two types of sorter: horizontal and vertical. This page contains the horizontal sorter, which can prepare twice as many orders with the same number of shuttles as the vertical sorter.



Horizontal sorter

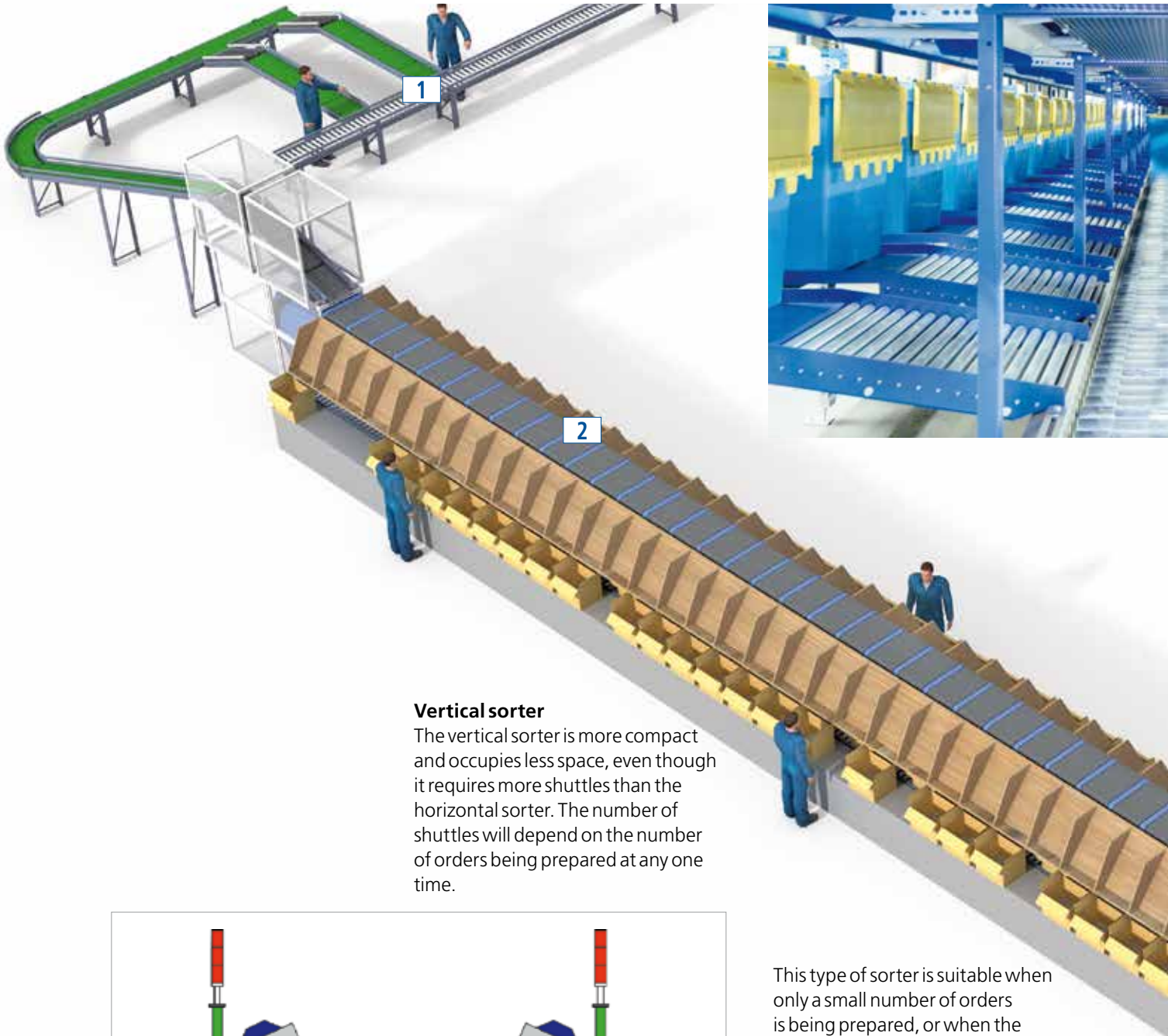

Vertical sorter

The vertical sorter is more compact and occupies less space, even though it requires more shuttles than the horizontal sorter. The number of shuttles will depend on the number of orders being prepared at any one time.

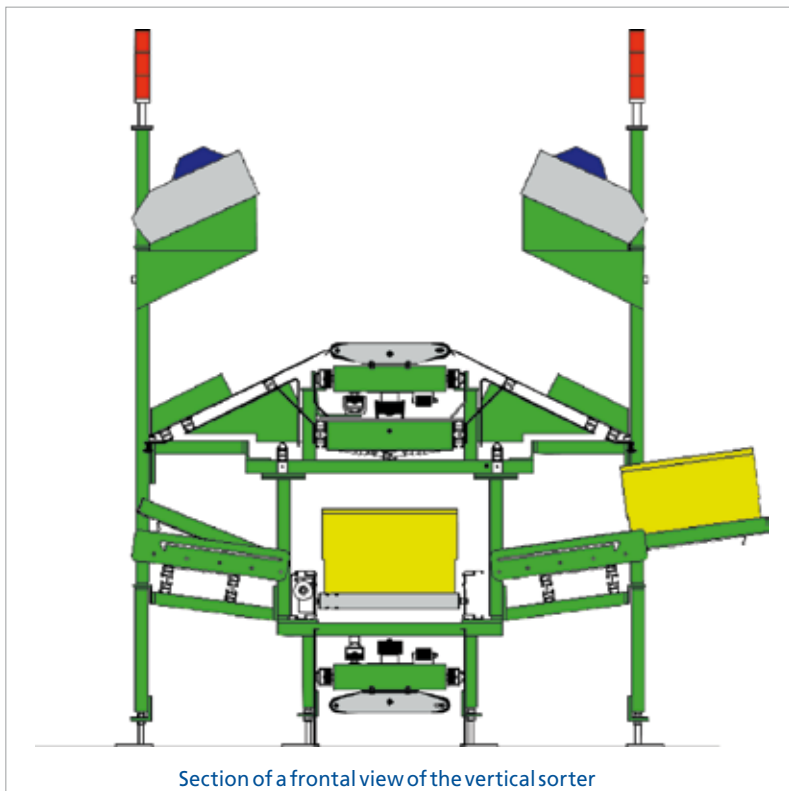

Section of a frontal view of the vertical sorter

This type of sorter is suitable when only a small number of orders is being prepared, or when the space required by the horizontal sorter is not available.

As can be seen in the images, the system is very compact. Internal conveyors can be used for boxes with prepared orders.

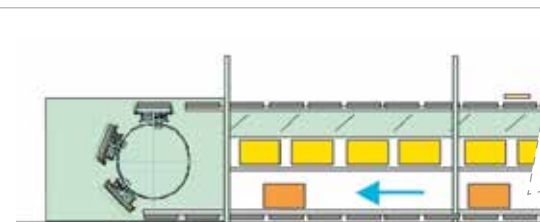

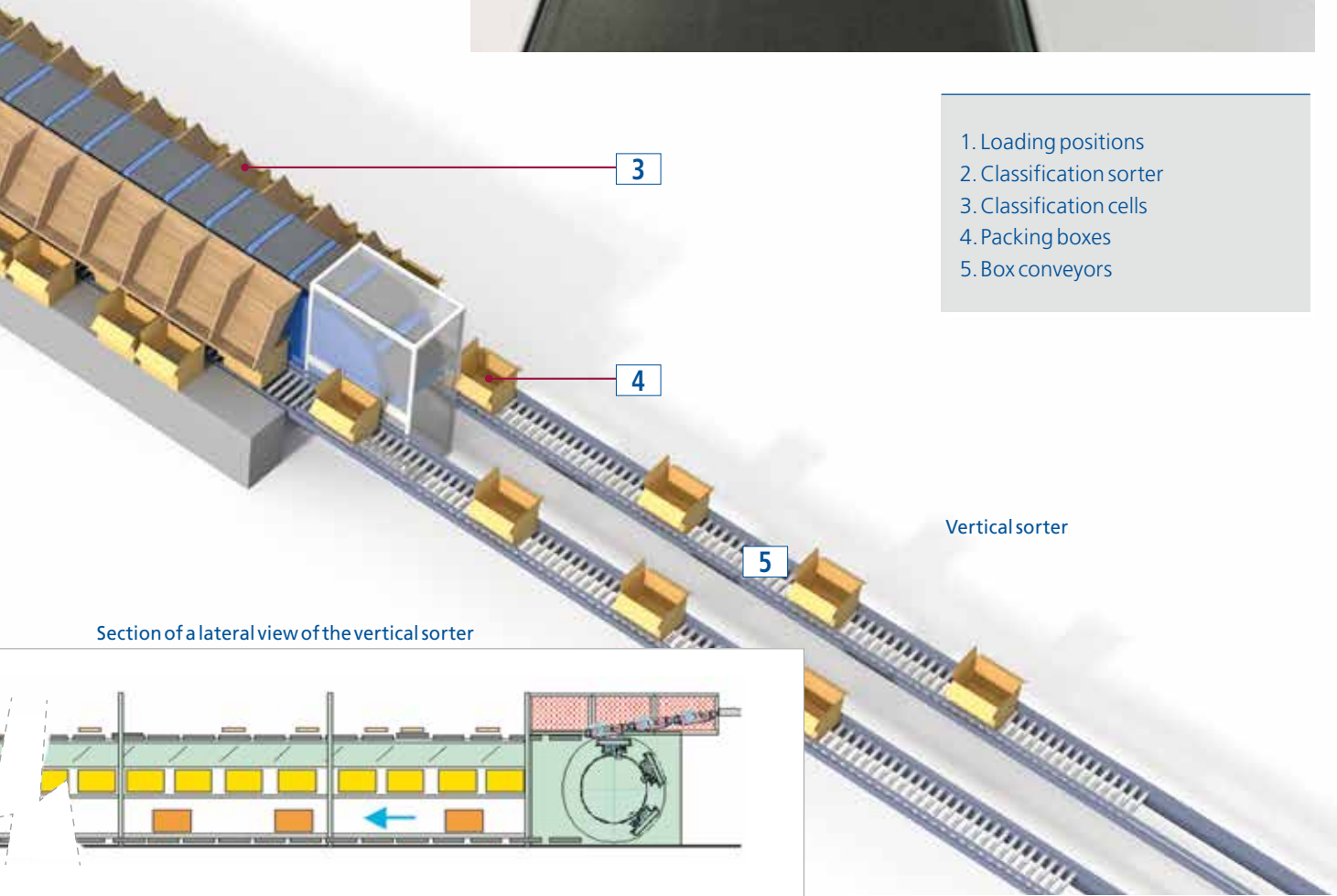

- 1. Loading positions
- 2. Classification sorter
- 3. Classification cells
- 4. Packing boxes
- 5. Box conveyors

Vertical sorter

Section of a lateral view of the vertical sorter

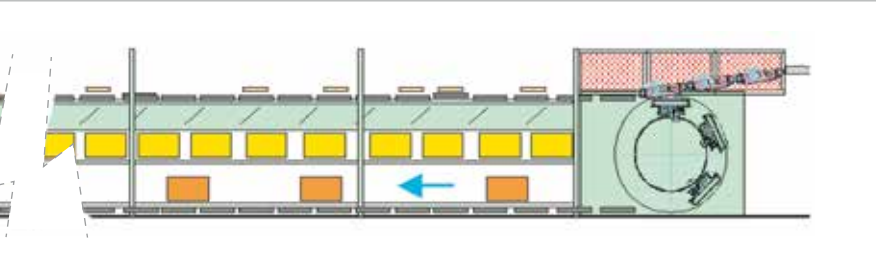



Easy WMS Warehouse Management System

The brain of the installation

Mecalux's Easy WMS platform optimises the physical and documentary management of product flows, ensuring traceability and multiplying throughput in all warehouse operations: goods receipt, storage, order preparation and dispatch. This platform's multi-level functionalities are suitable for any installation, regardless of size or sector.

Easy WMS has an extensive range of modules that cover all supply chain management needs.

Advantages

- > Receive real-time stock control
- > Lower logistics costs
- > Increase storage capacity
- > Reduce handling tasks
- > Eliminate errors
- > Get precise, high-speed picking
- > Adapt to new e-commerce needs
- > Manage omnichannel operations
- > Achieve a fast ROI



Mecalux works with leading suppliers that attest to the quality, reliability and technical level of the Easy WMS platform:



Interconnected solutions for your supply chain



WMS for Ecommerce supplements Easy WMS to manage the various storage scenarios required to pick orders for your online shop. Our solutions will make your warehouse more competitive and able to deal with the distribution of products sold online.



WMS for Manufacturing provides efficiency and traceability and creates value in manufacturing processes. It integrates production-line supply processes with products put away and later shipped out.



Supply Chain Analytics Software ensures fast, simple viewing of the different supply chain indicators, giving you first-hand knowledge of the tasks being carried out. Gain better control over your business and decision-making by keeping up to date with operational information.



Multi Carrier Shipping Software adds advanced WMS functionalities to manage operations related to packaging and labelling. Plus, you can use it to communicate with the major carriers automatically.



Store Fulfillment has been designed for companies that need real-time control over inventory in their warehouses and physical shops. Additionally, it synchronises provisioning operations — such as picking, replenishment, transfers between shops, and returns — throughout the distribution network.



Labor Management System (LMS) records real-time task performances and compares these to the estimated time standards for each operation.



Marketplaces & Ecommerce Platforms Integration synchronises the stock in your physical warehouse with that of your online sales catalogue. This module automates communication between logistics activities and virtual shops. The coordination of online sales with the WMS lets you combine management of the various digital sales channels and focus on providing agile, efficient logistics services.



Value-Added Services (VAS) integrates the value-added tasks carried out in your installation with Easy WMS. This module simplifies the work of operators, as they receive step-by-step instructions at their workstations. Thus, productivity increases, and, notably, errors made during operations decrease. This module ensures maximum agility and the elimination of additional costs relating to product personalisation in the warehouse.



WMS & Pallet Shuttle Integration comprises a single user-interface to run the WMS and the high-density Pallet Shuttle system, enabling users to easily control the Pallet Shuttles. This operation is integrated with the other warehouse fulfilment tasks.



The advantages of automation

As can be seen, there is a wide variety of possible solutions when it comes to building automated warehouses for boxes. The in-depth analysis of the needs of each client will result in the optimal system being chosen.

Special emphasis has also been placed on usual arrangements, which is to combine elements of different systems, each best suited to a specific type of product and operation.

Irrespective of the solution chosen, the highest degree of automation in management and appropriate software will be required to control the flows and needs of the warehouse.



Furthermore, automated warehouses for boxes automate the movements of the warehouse, since machines move about with the goods in question while the operator remains in their position. The more automated and flexible the picking position and the more efficient the support equipment chosen, the better the ultimate performance of the warehouse.

With automated warehouses for boxes, one can:

- **Optimise space and height.**
- **Maximise productivity** in picking operations.
- **Automate entry and exit operations.**
- Ensure **perfect control** of stock.
- **Eliminate errors** that result from manual handling in the warehouse.
- **Control and update inventory management.**

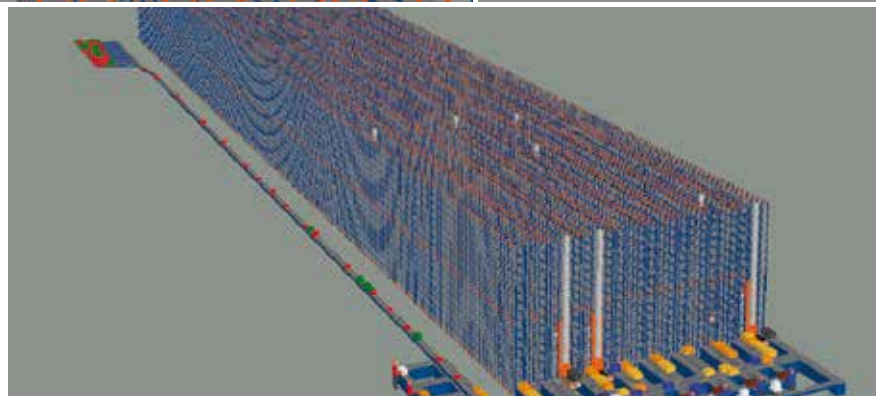
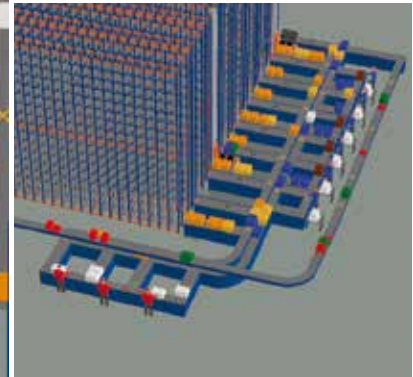
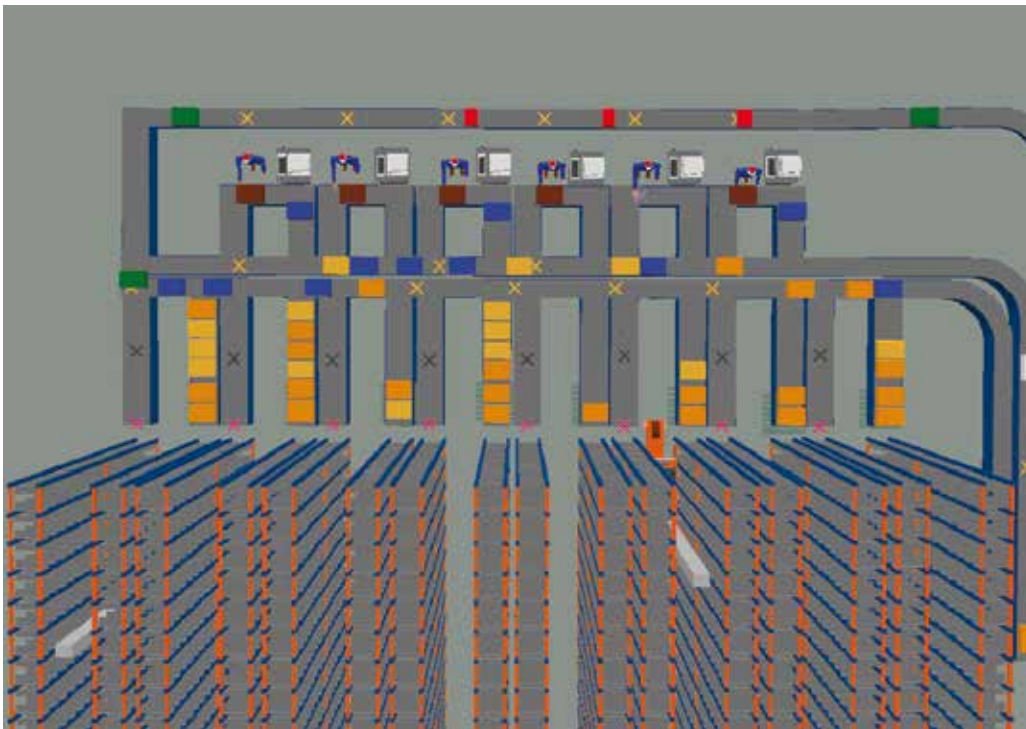

This involves an improvement in the quality of service, as well as a rapid amortization of investment.

The Mecalux technical departments will be able to advise you on how and when to automate your warehouse. Its experience in storage solutions and intralogistics, the powerful simulation equipment, and variety of products available will enable you to find the optimal solution for each type of warehouse.

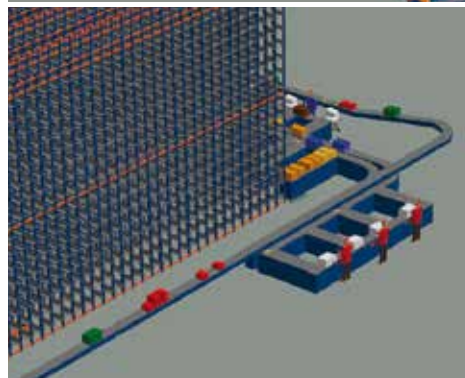

Example of simulation of an automated warehouse for boxes.

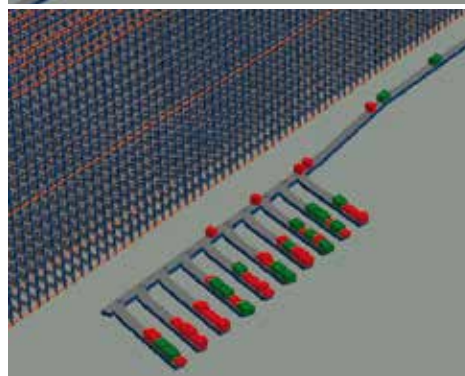

International presence





4 technological centres

- (1) In Barcelona, a research and development centre for **engineering projects** and **automated equipment**.
- (2) The centre for the development of **warehouse management products** and the **warehouse management system** is located in Gijón.
- (3) The research centre for **automated systems** is located in Gliwice.
- (4) In Chicago, Mecalux has another research and development centre **for engineering projects**.

Gliwice plant⁽¹⁾
(POLAND)
53,500m²



Barcelona plant⁽¹⁾
(SPAIN)
40,000m²

-  Sales network
-  Production centres



info@mecalux.co.uk - mecalux.co.uk

MECALUX UK LTD.

BIRMINGHAM

Tel. 0121 3336 602

Unit 8, Junction 6 Industrial Park
Electric Avenue, Birmingham B6 7JJ
West Midlands - (United Kingdom)

MECALUX, SA

HEAD OFFICE

Tel. + 34 932 616 913

Silici, 1
08940 Cornellà de Llobregat
Barcelona (SPAIN)

Mecalux has a presence in more than 70 countries worldwide

Offices in: Argentina - Belgium - Brazil - Canada - Chile - Colombia - Czechia - France - Germany - Italy - Mexico
Netherlands - Peru - Poland - Portugal - Slovakia - Spain - Turkey - United Kingdom - Uruguay - USA

